

~~2~~ 1-4-3
 3 2x 4-2
 2 2x 12-8
 \$15
 \$24
 \$44

↓
 \$83
 + hardware

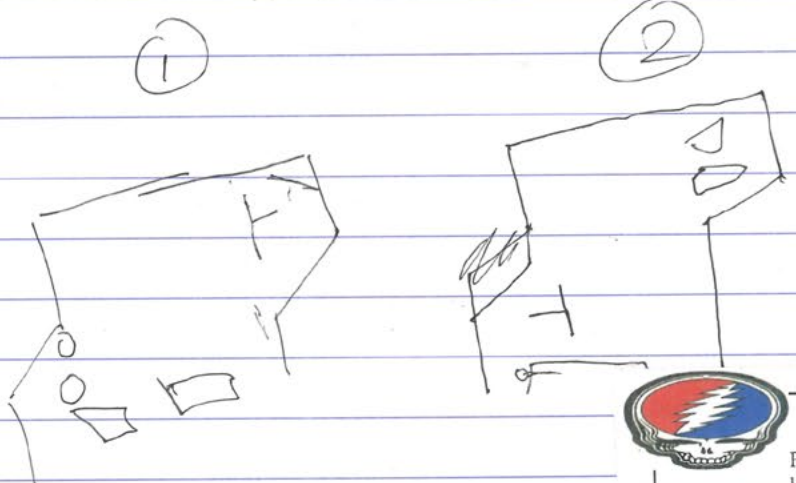
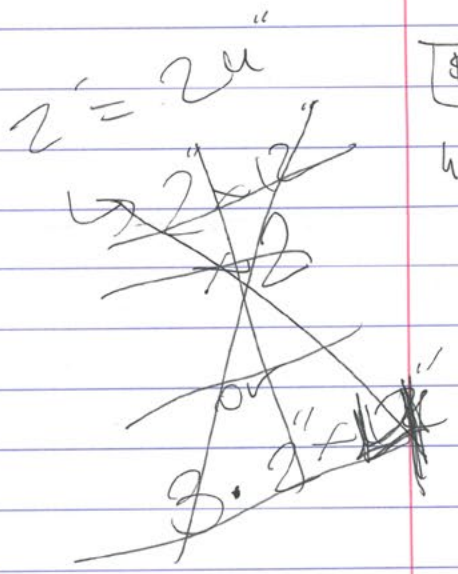

JAM BAND UPDATES

Phil Lesh & Bob Wier (Original Dead members) regrouped last fall as Furthur and toured the East coast. Several alums caught the NYC and Asbury park shows. The Dead's 2 drummers Bob Krutzman & Mickey Hart toured this fall as the Rhythm Devils and were around the NYC area in August. Jorma & Jack of Hot Tuna were also on tour.

Hours
 3.0

Project
 Slam Dunk the Junk

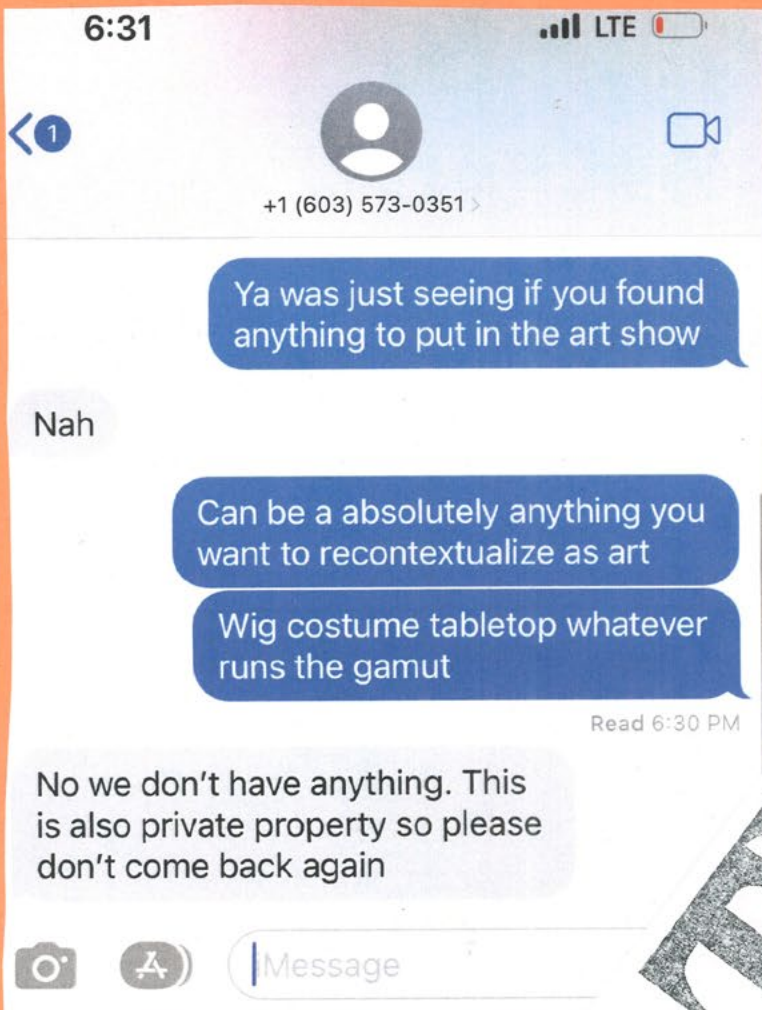

CANCEL TRIP!!!

Time Capsule
(Fall)

I will always be thankful to [redacted] for bringing together my family. My [redacted]-Big, Michela [redacted] is amazing → Spring of [redacted] I was very sick and would prepare me food that did not trigger my gallbladder attacks. It got me through finals week pain free. My big, Ashley [redacted], and I came together randomly, but we could not be a better match. She is so supportive and recognizes all of my work. She makes me feel very special. I love my little Jamie [redacted] and Samara [redacted], so much. I could not be happier trying to provide them with a loving + supportive home here in [redacted]. I am so excited to welcome new additions to my family. You will be so loved long after I'm gone.

Continue doing great things

♥ always,
Kelly

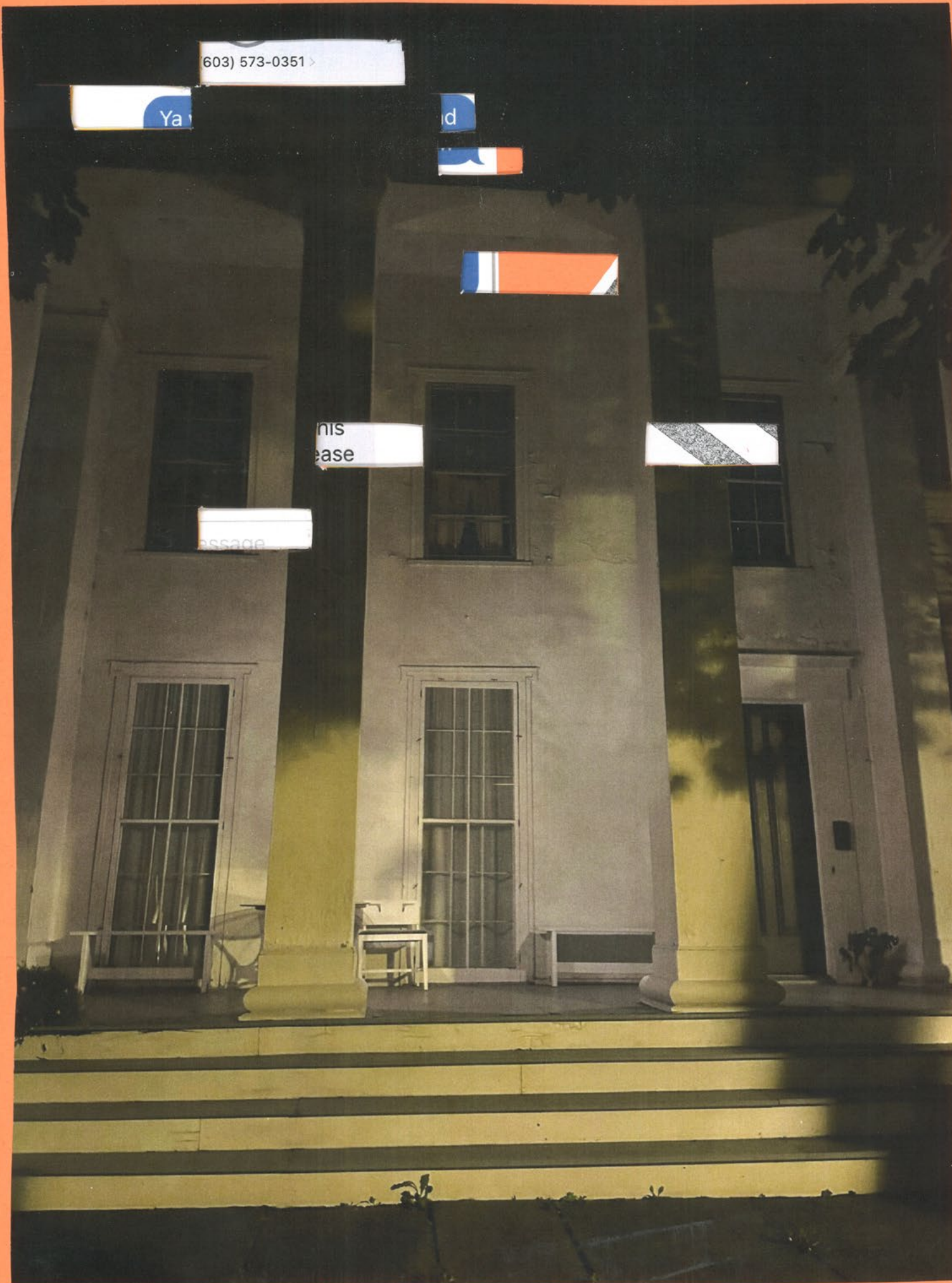



Michael B. Bay,
 Xi '86 (*Wesleyan University*): Director of music videos and advertisements, Bay won the Grand Prix

Clio for Commercial of the Year for his Got Milk/ Aaron Burr Commercial and has directed commercials for Nike, Reebok and Coca Cola. In 1995 he was honored by the Directors Guild of America as Commercial Director of the Year. He is best known as a director of feature films including *Bad Boys* (1995), *The Rock* (1996), *Armageddon* (1998), *Pearl Harbor* (2001), *Bad Boys II* (2003), *The Island* (2005), *Transformers* (2007) and *Transformers II* (2009).



10 Ways you can make a Difference

1. Turn down your water heater. For every 10 degrees, you save 6% of the energy used. The recommended setting is 130 degrees.
2. Put a plastic bottle in your toilet tank. You can save between 3,000 and 5,000 gallons of water a year.
3. Install low-flow faucet aerators and shower heads. A family of four can save 17,000 gallons of water a year.
4. Keep your car's tires properly inflated. You will increase gas efficiency by up to 5%. About 50% of America's cars have under-inflated tires. If they were all inflated properly, we could save up to 2 billion gallons of gasoline a year and prevent up to 40 billion pounds of carbon dioxide, the primary "greenhouse gas", from entering the atmosphere.
5. Bring your own shopping bag. It takes a 15 year-old tree to provide 700 grocery bags, and grocery shoppers use billions of bags every year.
6. Eliminate waste before you buy. Packaging waste accounts for about one-third of all the garbage Americans send to landfills.
7. Recycle cans, glass and paper. The energy saved from one recycled aluminum will operate a television set for three hours.
8. Replace a regular (incandescent light bulb with a compact fluorescent light bulb. It uses a quarter of the energy and will last 10 times longer.
9. Buy rechargeable batteries for household use. Americans use 2 billion disposable batteries a year and 75% of them contain mercury, a highly toxic substance that can leak from landfills into soil and ground water.
10. Set the blades higher on your lawn mower. Forget the manicured look, and cut the grass two to three inches high. This encourages the roots to grow deeper and helps retain moisture in the soil, requiring less water.

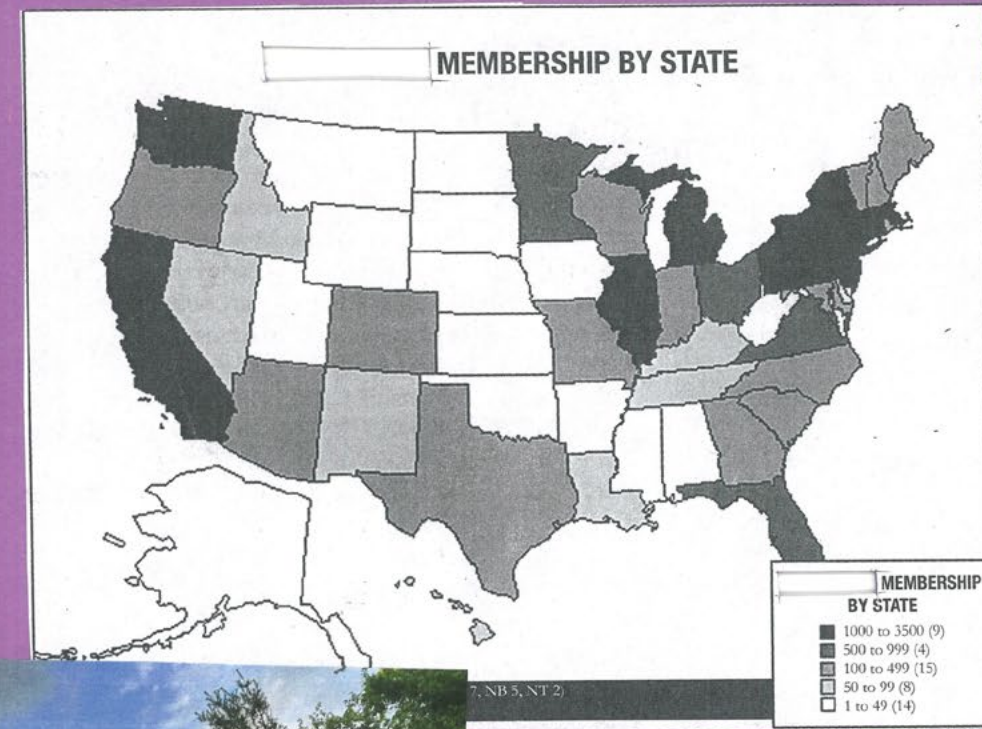

DON PEPE RESTAURANT

844 McCarter Hwy.
Newark, New Jersey 07102
(201) 623-4662

MENU FOR WEDDINGS OR SPECIAL OCCASSIONS

6 Hour Party with Open Bar
Name brand liquors and beer

COCKTAIL HOUR

Shrimp, clams, mussels, oysters, seafood salad, cold salad, cold cuts, stuffed mushrooms, broiled fish, roast suckling pig, ribs, meat cakes, roast chicken, spanish omelets, olives, celery, squid, etc...

CHAMPAGNE TOAST

Soup

Green Salad

FILET MIGNON

served with fresh vegetables and potatoes

Wine, sangria, beer and soda at table





Coffee and cake

→ ** SPECIAL SHEET CAKE

VENETIAN TABLE

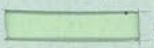

PLEDGE QUOTES

1. I am a pledge. A pledge is the lowest form of an amoeba on earth. A pledge is an ignorant individual, unable to make decisions for himself, and can only follow the orders of the Honorable Brothers of  XI 
2. Sir, I am greatly embarrassed and deeply humiliated that due to circumstances over which I have no control, the inner workings and hidden mechanisms of my chronometer are not in accord with the great sid ral movements by which time is commonly reckoned, however, Sir, without fear of being too greatly in error, the time is approximately _____ minutes, _____ seconds, _____ ticks, past the hours of  Sir.
3. Sir, I am greatly embarrassed and deeply humiliated that this is a wrong quote.
4. Sir, I am a pledge. A pledge is the lowest form of animal life. It is lower than the deepest layer of whale feces in the deepest ocean, but higher than the sage of .
5. A common is a coordinating conjunctive implement in common  colloquialism combining complicated coordinated phrases consisting of complete conjectures of the cranium, Sir.
6. Sir, "Sir" is a subserviant work surviving from the early days in old Serbia when certain serfs, too ignorant to remember their lords names yet too servile to blasphame them, circumvented the situation by surrogationing the subserviant work "Sir" by which I now belatedly address a certain Brother who correctly surmised that I was inconsiderate enough not to say "Sir" after every work I said, Sir.
7. How's the cow?
Sir, she walks, she talks, she's full of chalk. The lactile fluid extracted from the female of the Bovine species is highly prolific to the Nth degree, Sir.
8. Sir, you spell "Sir", Sir, capital S, Sir, Capital I, Sir, capital R, Sir spells "Sir", Sir.



UPPER			ALPHA		XI	X
			LOWE		OMICRON	
					PI	
					RHO	
					SIGMA	
					TAU	
					UPSILON	X
					PHI	
					CHI	
					PSI	
					OMEGA	



LOST ALUMNI SHEET

NAME:

ADDRESS:

TELEPHONE:

YEAR GRADUATED:

PLEDGE CLASS:

INFORMATION PROVIDED BY:

2 or 1
142.00

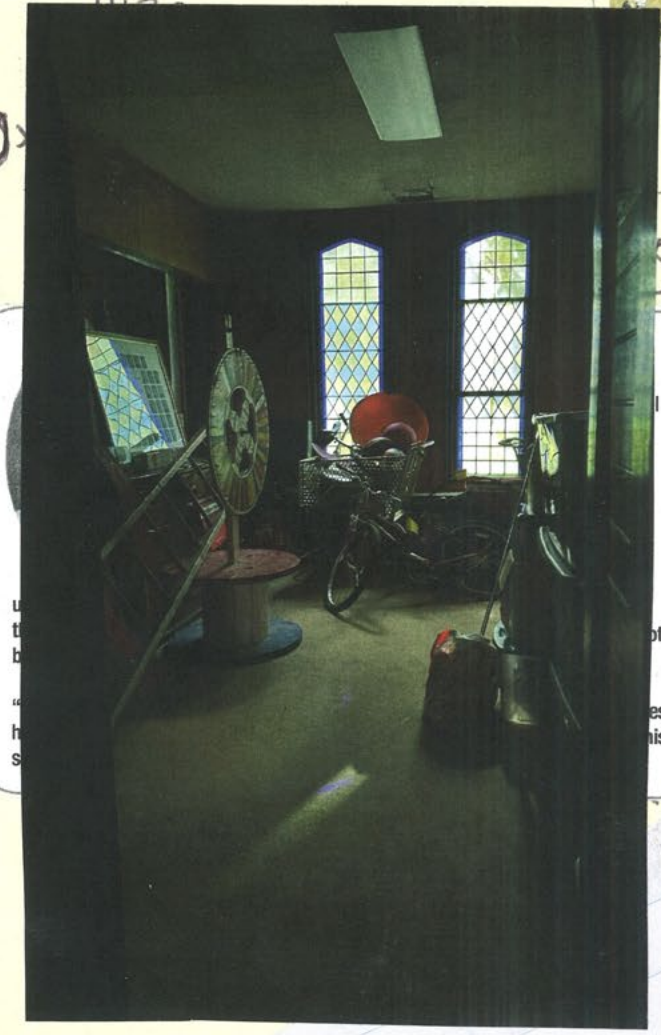

units at and selling
units at 179.00 to make
plus 4 unit

Why I love them

FRATERNITY

Out of this somewhat stifling atmosphere, a new type of society emerged. Smaller than the literary societies, secretive in nature to avoid reprisals from faculty and other students, and selective based on friendship and shared values, general fraternities filled an unmet need for college students. In the confines of the chapter meeting room, students were able to exercise their intellectual freedom, discuss events of the day, and share concerns in an open and supportive environment. The first example of this type of society originated at the College of William and Mary where, on December 3, 1776, five students met in a tavern in Williamsburg, Virginia, and founded [redacted].

This earliest Greek-letter society traces its origins back to the Flat Hat Club, or F. H. C., which has existed at William and Mary since 1750. From the beginning, [redacted] had many of the traits of most fraternities as they are known today. Friendship, comradeship, and high ideals were the common bond which united these college men. In addition they had a ritual, secret vows of fidelity, a secret handshake or "grip," a motto, and a badge. Not long after its founding, the society grew to include chapters at Yale, Harvard and Dartmouth. The Revolutionary War

FOUNDATION



REVENUE SOURCES

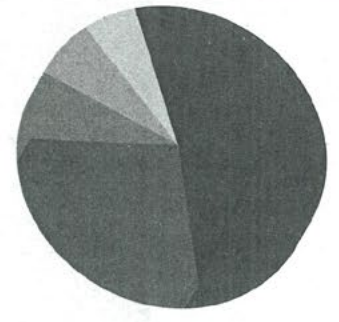

- 52% Undergraduate Assessments
- 26% Risk Management Assessments
- 8% Alumni
- 7% Convention Registrations
- 6% Foundation Grants and shared expenses

EXPENSES

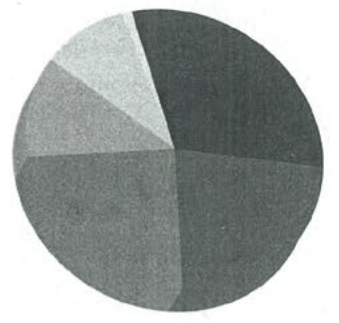

- 30% Salaries
- 24% Liability Insurance
- 23% Member Services
- 12% Convention
- 10% Operating
- 1% Fundraising

REVENUE SOURCES

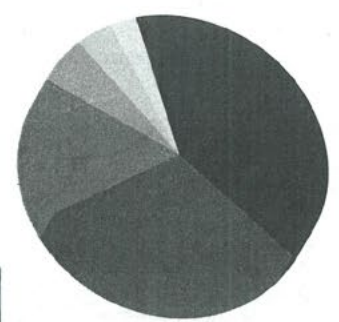

- 41% Leadership Initiative Campaign
- 30% Annual Fund
- 16% Bequests
- 6% Investments
- 4% Rental Income
- 3% Scholarship Funds

EXPENSES

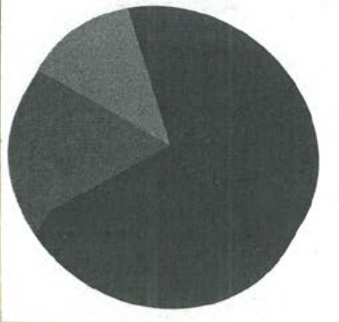

- 70% Educational Programs
- 17% Fund Raising
- 13% Operating

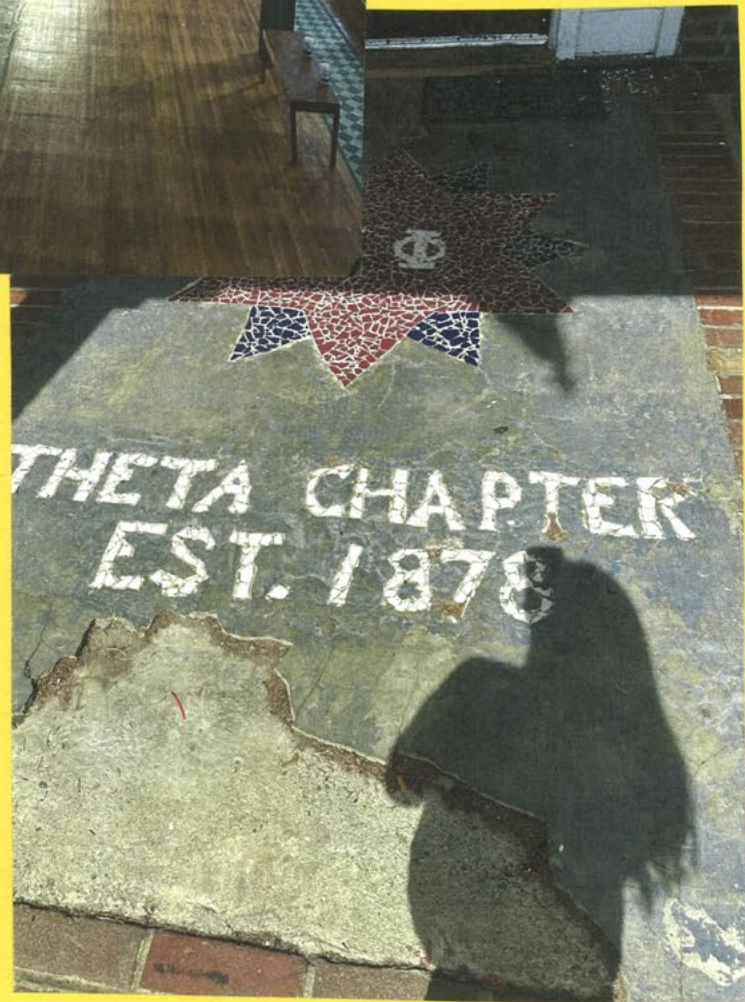
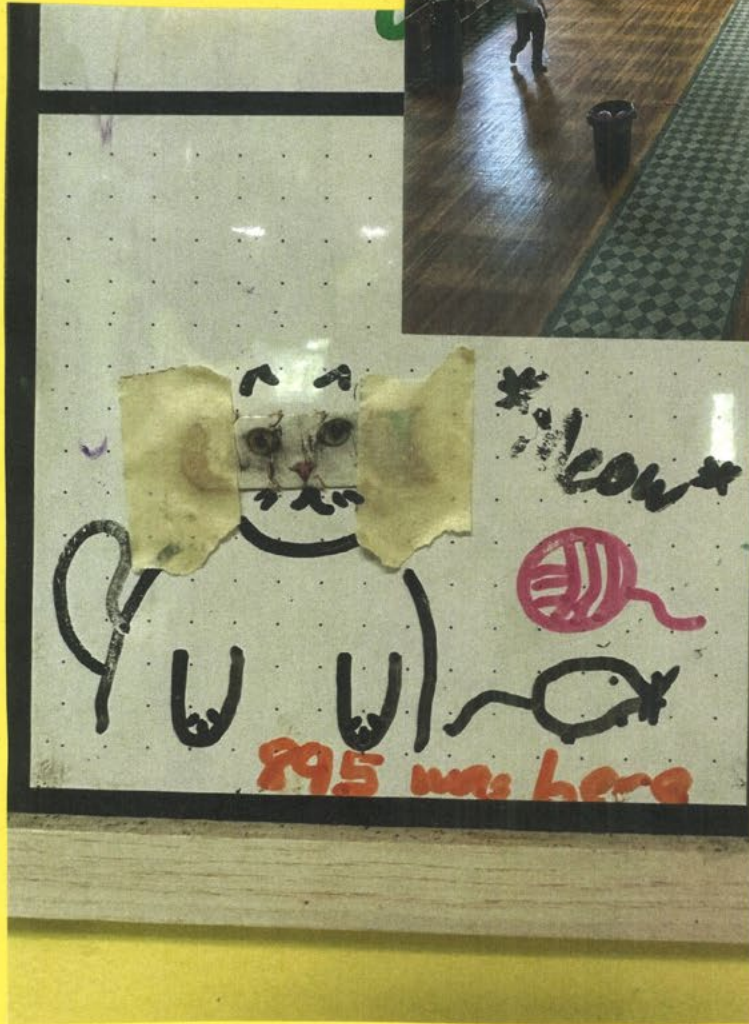
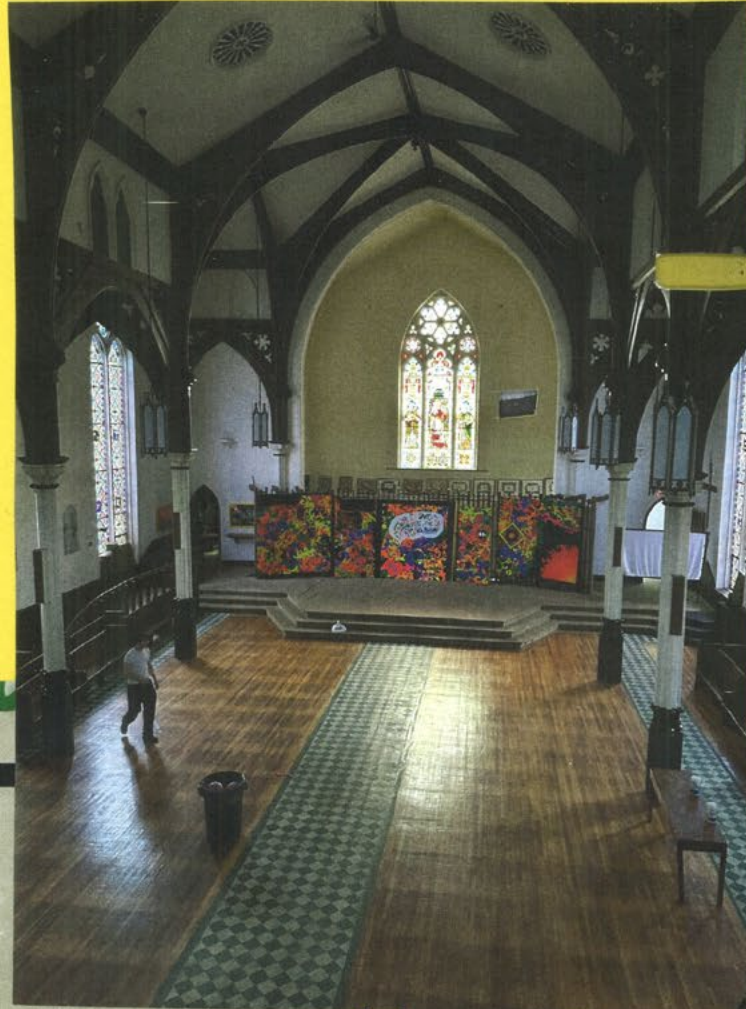

Fireside chats always make me feel at home. I love bonding with my sisters

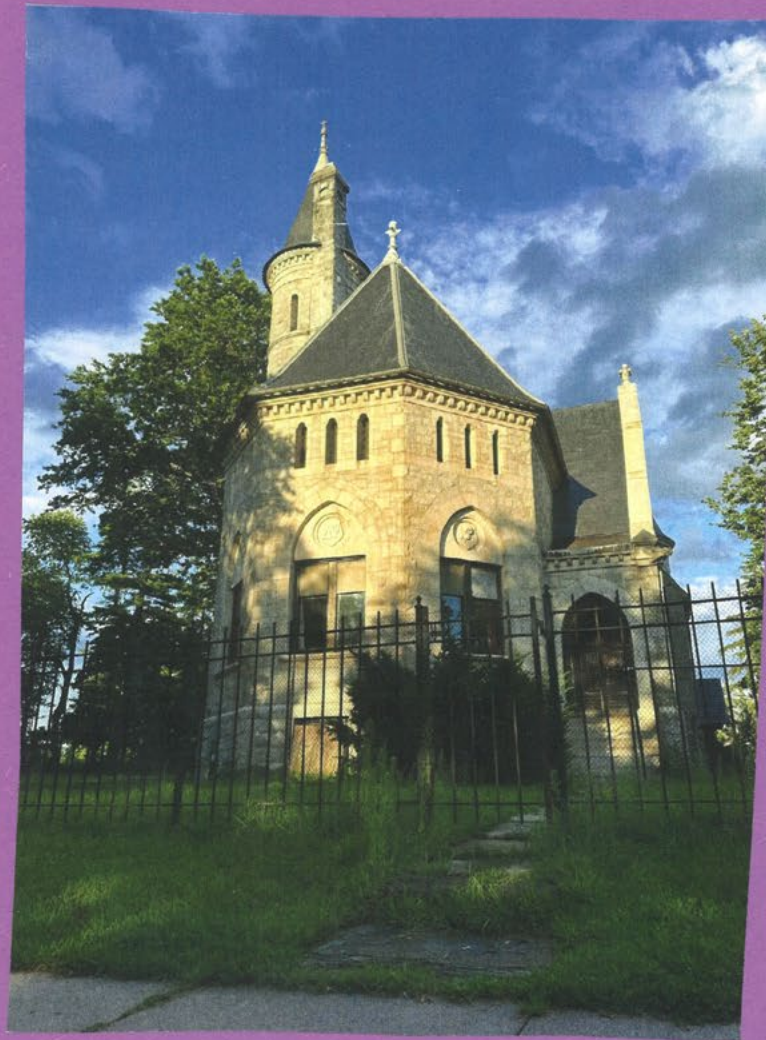

HOUSE RULES OF [REDACTED]

AS REVISED

October 29, 1974

House rules are for our own benefit and are only as strong as we make them. They are to be interpreted with common sense and not read into.

1. No fornication will be tolerated [REDACTED]. Any affiliated person who disregards this rule shall be brought up for disorderly conduct. Any non-affiliated person will be barred from the house.
2. Girls will be permitted in private rooms only on the condition that the rooms are not locked and easily accessible. A person guilty of this offense shall be brought up before the Executive Committee.
3. The defacement of [REDACTED] property shall deem it necessary, the offender account to the Fr [REDACTED] John has moved for his actions at a regular meeting. A fine will be imposed by the Executive Committee subject to approval by the Brotherhood.
4. Quiet hours are established between the hours [REDACTED] 12:01 a.m. and 8:00 a.m. on nights prior to school days other than those allotted to Fraternity functions. Any Brother may impose a fine not exceeding one dollar for each offense.
5. A Brother will assume full responsibility for any of his guests.
6. No disorder or untidiness, hereafter referred to as litter, will be tolerated in the public rooms of [REDACTED]. Personal items of value which litter public rooms may be confiscated by any active Brother to be turned over to the Chairman of the House Committee until the designated fine for littering is paid. Maximum fine shall be one dollar for each offense.
7. No consumption of food will be permitted in the front room of [REDACTED] except during regular social functions. Any Brother may impose a fine not exceeding fifty cents on all offenders.
8. No discharge of fire arms will be permitted on the premises of [REDACTED]. No fire arms will be kept loaded.
9. No game playing will be permitted in the kitchen between 11:00 a.m. and 2:00 p.m. on school days.
10. No one, excluding live-ins, will be allowed in the house without a Brother present.
11. A charge of disorderly conduct and a minimum fine of ten dollars will be imposed on anyone tampering with the house fire alarm system.
12. The person doing K.P. will be responsible for locking all doors and shutting off all unnecessary lights each night.
13. No one is permitted on the roof of the house, except for repair work. Minimum fine five dollars.



- ♥ my favorite memory is when Salina ran back and forth in our rooms for an hour during midterms. ♥
- Running to Steph Consoli & Liv on bid night
- Float building with
- Living with Miida
- Getting ready for semi/formal with my friends

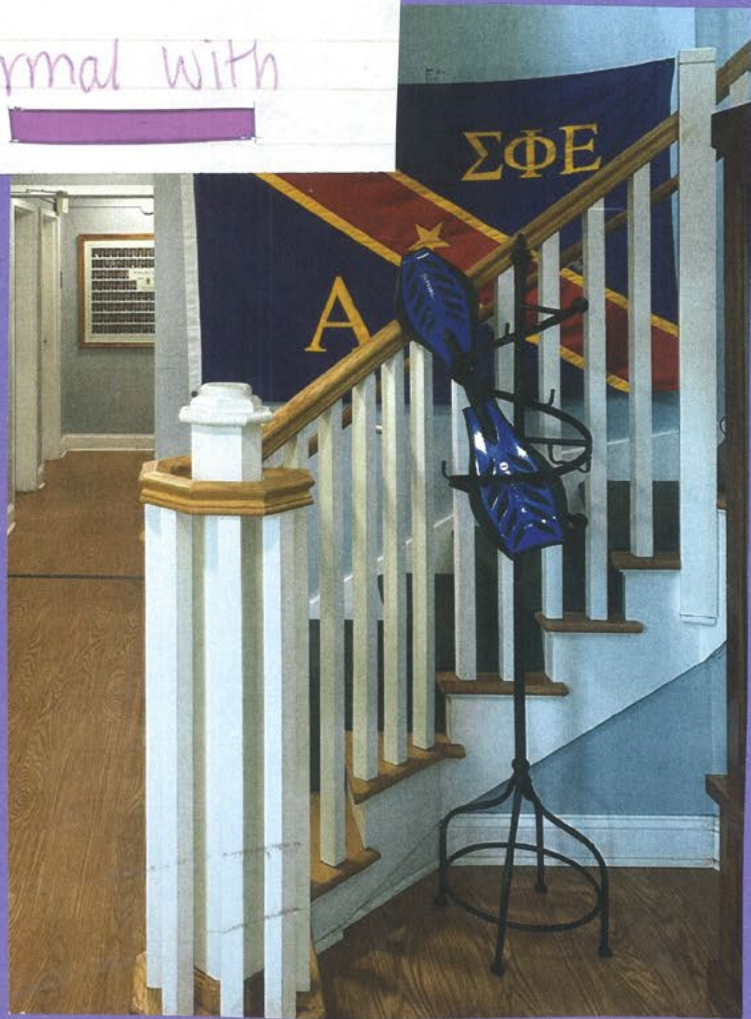

John has moved to Houston Texas and lives with wife and 2 children. He has worked all over the world in his capacity as an Computer Analyst. His favorite Fraternity moment was Stealing the fire hydrant.



My first recruitment with
 Salina when she had set
 out to make me her friend
 #forcedfriendship



This year I came back to
 school excited to start soph.
 year & live in the ville. After
 the first week, I was forced
 to go home due to tragic
 family matters. The love and support
 that I have gotten from ~~pe~~ women
 that I am not even close with in
 this chapter has been truly touching.
 After missing an entire week of
 school I was welcomed back with
 more love and support than I could
 ever imagine. GPhi has made me who
 I am today. ♡

UPPER

A

B

Γ

Δ

E

Z

H

Ⓜ

I

K

∧

M

N

LOWER

α

β

γ

δ

ε

ζ

η

θ

ι

κ

λ

μ

ν

ALPHA

BETA

GAMMA

DELTA

EPSILON

ZETA

ETA

THETA

IOTA

KAPPA

LAMDA

MU

NU

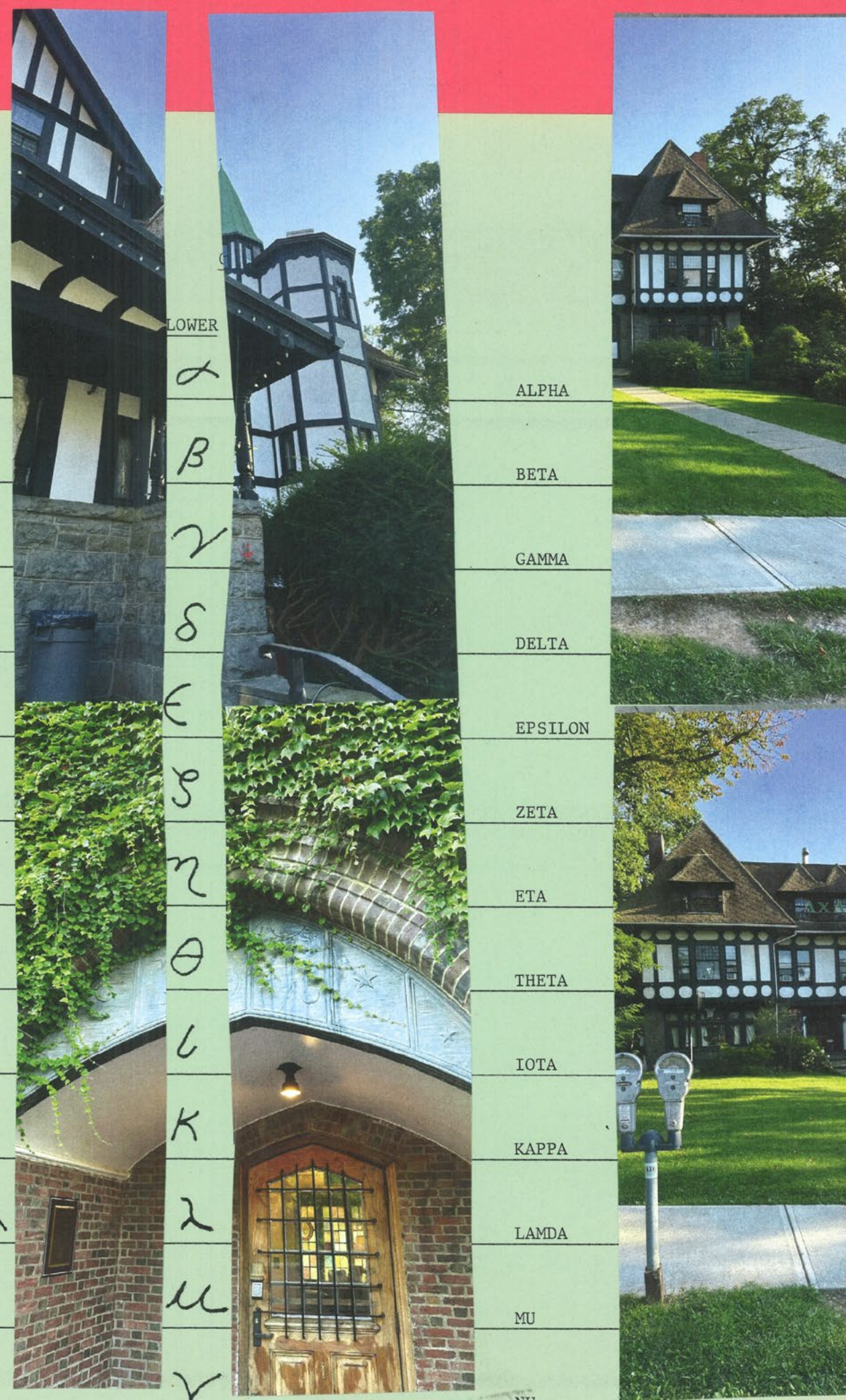

IKΦ LETTERS TO BE 3.81 CM HIGH, 2.54 CM. WIDE, SPACED 2.54 CM.
 APART, OF UNIFORM THICKNESS & CENTERED IN ALL DIRECTIONS.
 LETTERING & STRIPES TO BE FOREST OR KELLEY GREEN
 HIGH GLOSS ENAMEL

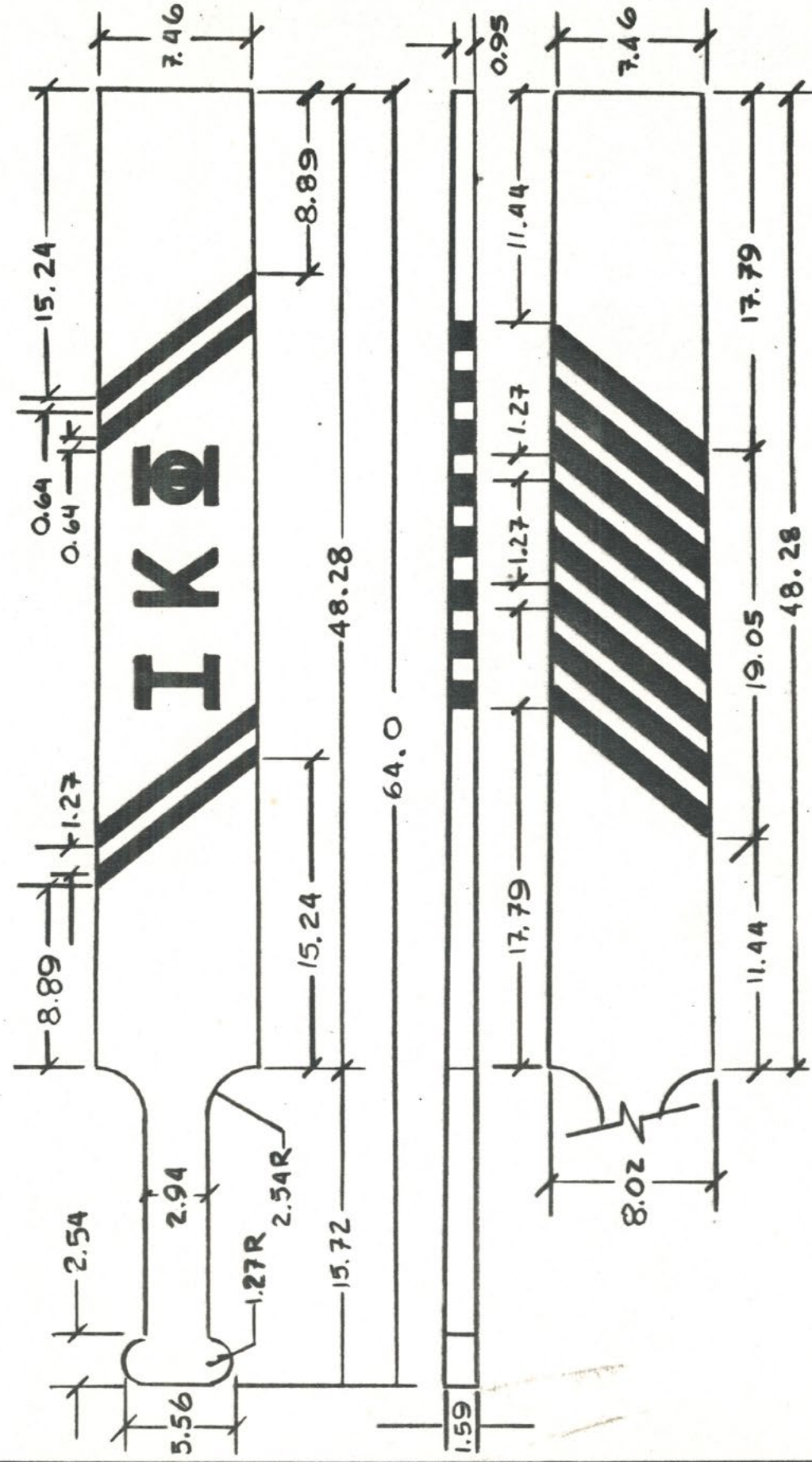

MATERIAL: WHITE PINE ALL DIMENSIONS IN CENTIMETERS

IKΦ PLEDGE PADDLE SPECIFICATIONS



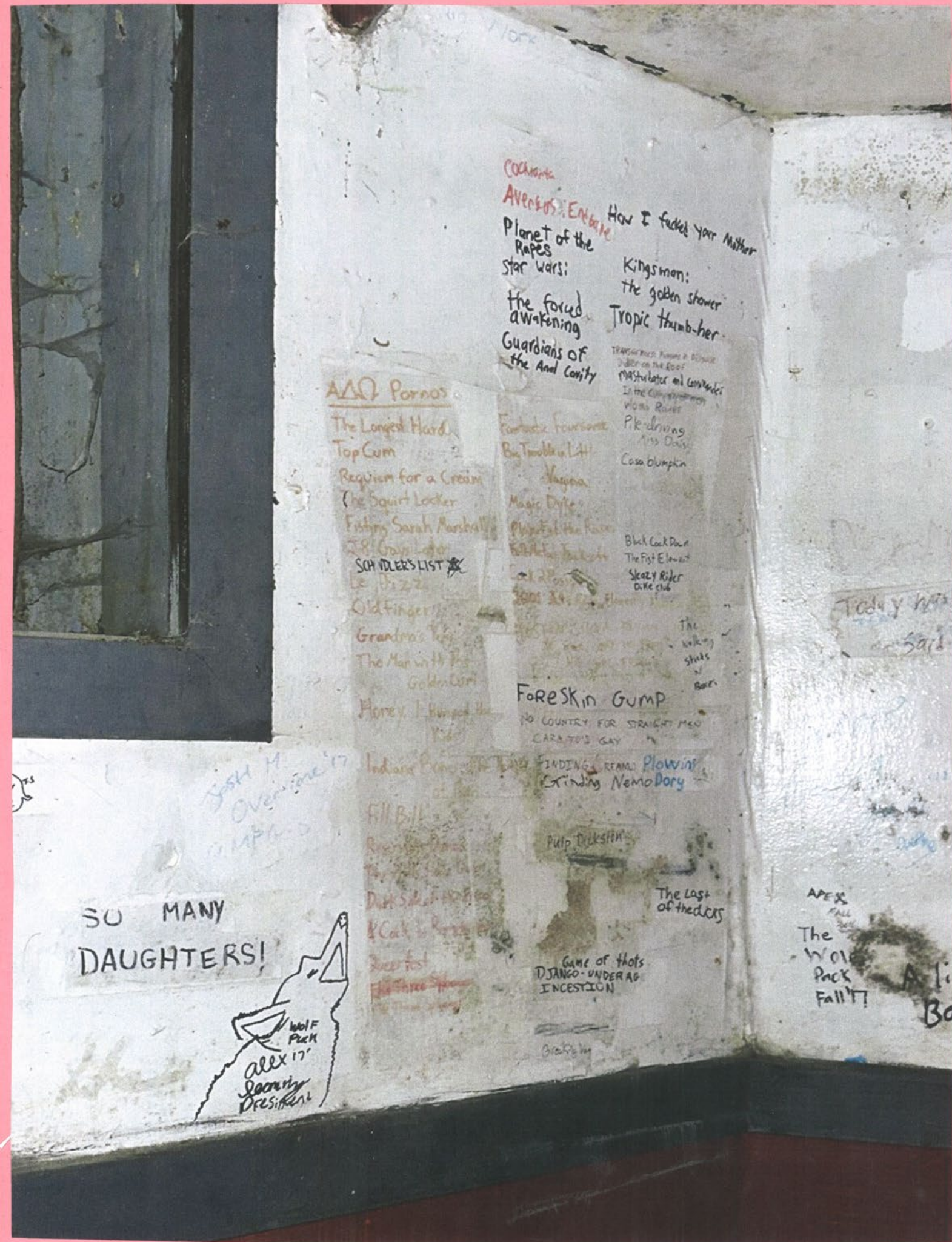

Big/Little
Reveal!
- I remember I was
the last to find my
big because I was
looking for the wrong
side of the wrapping
paper! Then we all
went out for a pham
lunch. 😊







COVERAGES PROVIDED							
ITEM NO.	COVERAGE	LIMIT OF INSURANCE	COVERED CAUSES OF LOSS	CO-INSURANCE	RATES	PREMIUM	
1	BLDG	150,000	<input checked="" type="checkbox"/> FIRE, LIGHTNING & EXPLOSION <input type="checkbox"/> VANDALISM <input type="checkbox"/> SPRINKLER LEAKAGE	80%	.785	\$ 1178.00	
1	BLDG	X X X X X X X X X X	<input checked="" type="checkbox"/> WIND OR HAIL, SMOKE, AIRCRAFT OR VEHICLES, RIOT OR CIVIL COMMOION, SINKHOLE COLLAPSE, VOLCANIC ACTION	80%	.164	\$ 246.00	
DEDUCTIBLE: \$250. EXCEPTIONS:						TOTAL	\$ 1424.00
						TOTAL REQUIRED PREMIUM	\$ 1424.00
MORTGAGE HOLDERS							
ITEM NO.	BLDG. NO.	MORTGAGE HOLDER NAME AND MAILING ADDRESS					
FORMS APPLICABLE							
CP 00 99 (10-91)		NJ CP-520 (11-89)					

Agency at Newark, N.J.

APR 13 1994

Countersignature Date

Samuel Freeman

Agent

POLICY

FORM NO. NJ-2CP (9-87) COPY 2



PINNING CEREMONY

The Brotherhood of [REDACTED] has recognized your interest in our organization and has invited you to become an associate member of the (PLEDGE CLASS) pledge class.

Repeat after me:

I, (State your name), pledge to uphold the ideals and traditions of [REDACTED] BLDG [REDACTED] to the best of my ability. I will wear this token, in best faith, knowing that it represents the brotherhood of [REDACTED] \$ [REDACTED]

Your big brother will be:

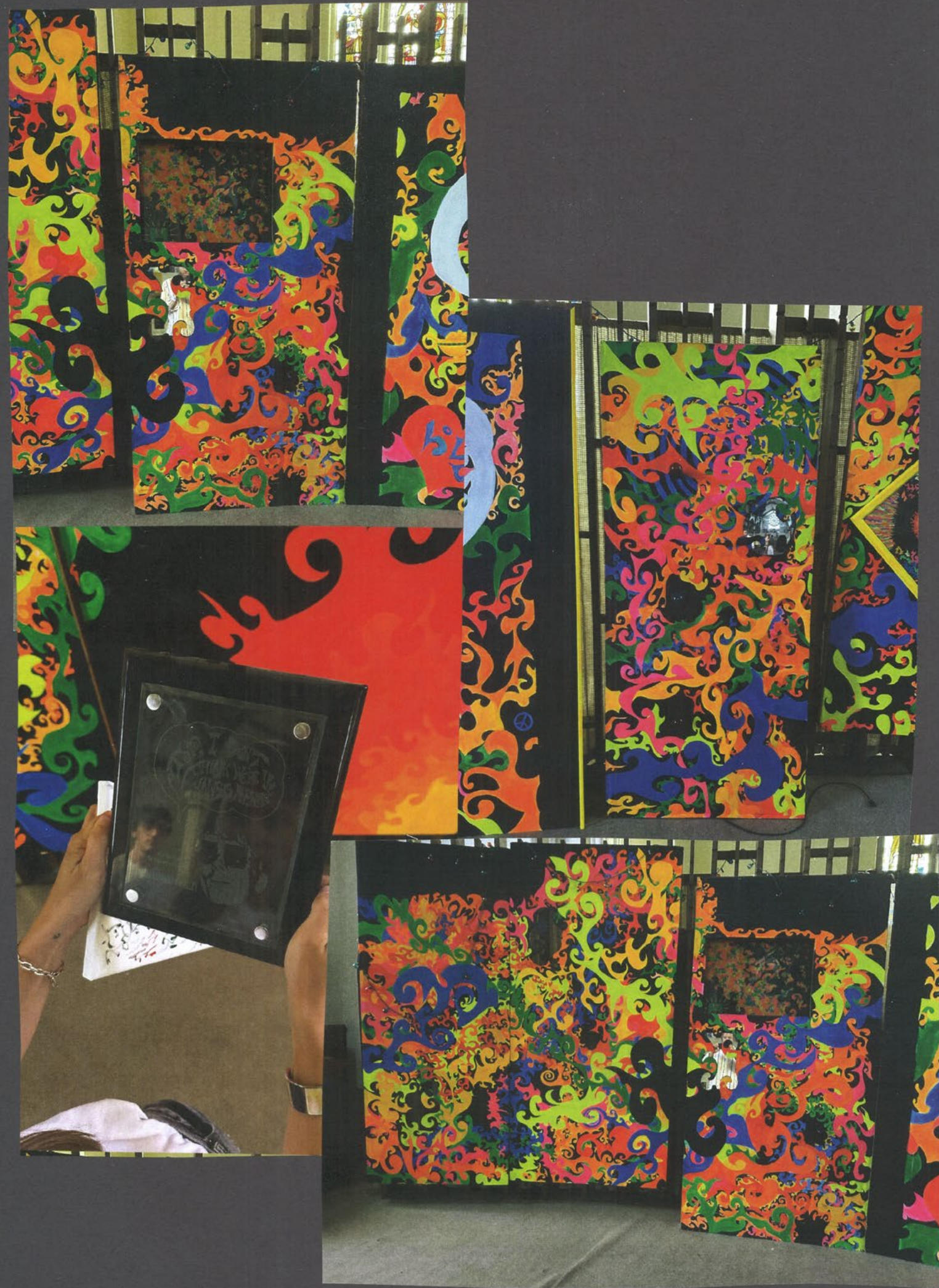



Alpha Rho Tau Artist Galleries



BILL TUCKER

Back in April I asked for some beta testers. Some people to come push the buttons and not get discouraged and help me find out if there are any errors. Well, I still needed beta testers so right before the storm and the blackout I asked Ken to send some people to sign up. I want to thank you guys for being unwitting beta testers I found a couple of errors. And amongst the people that I

AA alpharhotau.org



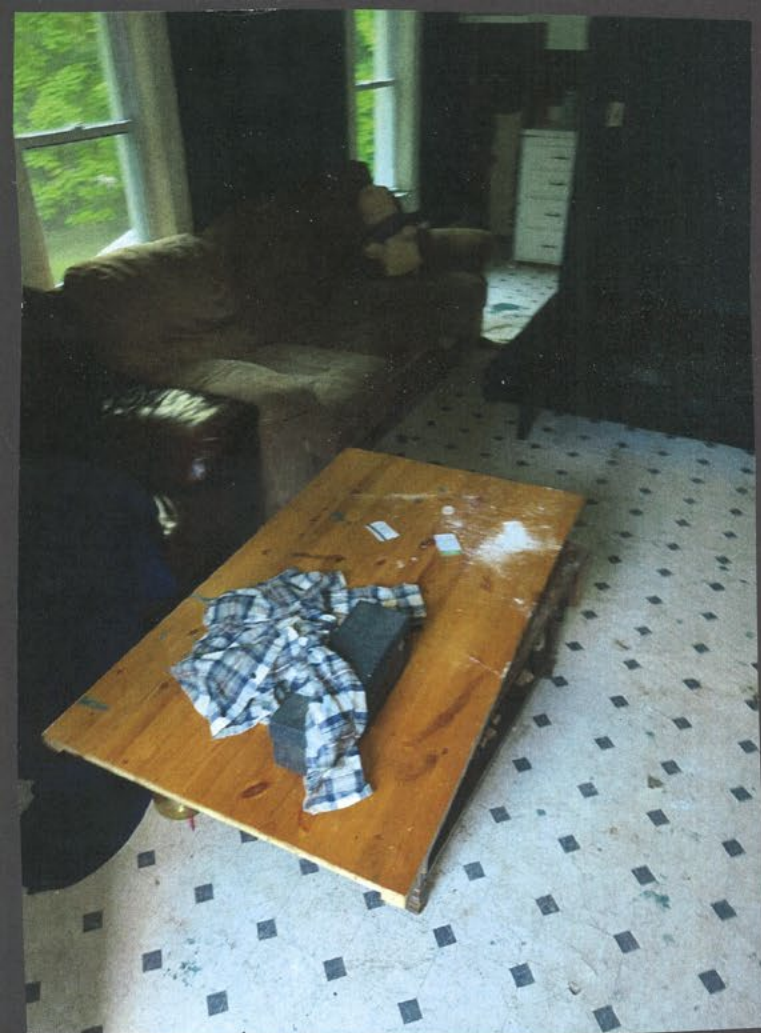

Hey snitches ♡

I am currently writing this on a pizza crumb coated common room floor in the middle of a sisterhood event but I have an ENDLESS amount of favorite [redacted] moments of the house, whether [redacted] moments, here is 6:

- ↳ When I joined [redacted] with [redacted] (the most lit pledge class ever) + knew after bawling my eyes out at the pref ritual as Toni sang Never Alone w/ Jacquelyn, that this was my FOREVER home
- ① When I spoke w/ one of my (future) littles, Emily on preference. I never got to truly express why I loved [redacted] so much, to a woman who would shortly feel the same
- ↳ GETTING my BEAUTIFUL, amazing, INSPIRING, WILD + badass little, Kayla Waring + Emily
- ③ [redacted] at big/little reveal. I love them more than they know and I can say that they have helped me grow... and that I have been changed for good 😊
- ↳ When [redacted] got INITIATED!! ♡ ♡ The newest nuggets, making me SO PROUD!
- ④ somehow felt even more like home w/ their addition
- ↳ My final pref (& it was to Audrey, younger sister) and BID DAY/NIGHT that I worked so hard to plan. My apartment floor still says we mermaid for [redacted]... you're welcome hilltop. This also is big to me because I'm the NME of a group of 51 outstanding new members that have already shown so much ♡, loyalty + growth in 2 weeks! I can't wait to watch them grow with [redacted]. They're like my other →

2ND MEETING
1-28-07

PRICED
1st [REDACTED] BACK PARTY

NEED
2 KEGS
4 BOTTLES OF WINE (JUGS)
45 CUPS
25 COZ
45 CUPS

TOTAL EXPENSES \$587.41

RUSHES

6 KEGS + tax = 420
52.4
420
400
20

(8) dep. KEGS 467.83
(1) CUPS 44.33
[REDACTED] 23.90
(1) PUNCH 6.30
(4) VADKA 42.76

52.50
52.50
45.00
45.00
195.00

1:30 EVERYONE STAYS.
2:00 Kill music.

WAS NJIT
PAKI
CHEM
ENG.
732-725-231

UPCOMING EVENTS

B-DAY PARTY THIS WED? WE GET ONE KEGG
105.00
85.57

- * No. PANTS PARTY
- *** POKER TOURNAMENT (wait for planning?)
- ***** LATE-NIGHT LINGERIE
- ** MARDI GRAS
- * ST. PATRY'S DAY

Room PARTIES
NICK
RYAN (-)
TURTLE
PHIL
THIS WEEKEND
2 KEGS
SANGRIA

MIXERS	SCHOOL	SORORITY	CONTACT	DATE	THEME?
	[REDACTED]	ΣΣ	ANGELICA	1-29-07	70'S THEME
	SETON HALL	ΑΓΑ	KATHLEEN	2-13?	BOARING 20'S
	KEAN	ΔΦΕ	NGAN	2-21-07	
	NJIT	ΑΣΤ	JEN & LIZ		
	MONTECLAIR	ΣΑΤ	JENNA BOCA		
	MONMOUTH	ΣΔΦ			

I just want to update you on our current corporation status. Unfortunately, for whatever reason, our status as a corporation lapsed. I am trying to get us reinstated as a corporation. I am also trying to get tax exempt status. This will greatly improve our funds.

Another point I would like to make is that we still have lost alumni. If you know anyone on our list please have them contact me at the house. We are trying to construct family trees and we need your help. We also need you to send in your alumni profiles. The profiles book was a great success at the Dinner Dance and brought many alumni together with old friends.

I would also like to say that we have been seeing many alumni drop by the house. I would like to thank those of you who have and encourage those of you who have not. Your participation is very important to us. We go through a lot of trouble to get a schedule of events to you, and would like to see you at them. If you have any questions feel free to call us.

The first alumni meeting was on Feb. 8. This meeting discussed many ways of bringing our alumni together. The first point I would like to make is that Parents Day is still open to all alumni. I will speak for the Brotherhood and say that we want our parents to see graduates of the house, whether it be a recent grad or 20 years ago. Parents Day is on April 22 this year, we would like to see you there. Remember, wives and children are welcome and don't forget to bring a dish of some sort.

Next, I would like to address the Summer Picnic. This picnic will be on Aug 11, with a rain date on Aug 18. The place has not been set yet, but it will be in the next newsletter. The picnic is for all family members and promises to be a very good time. If you have any questions, don't hesitate to call us at the house

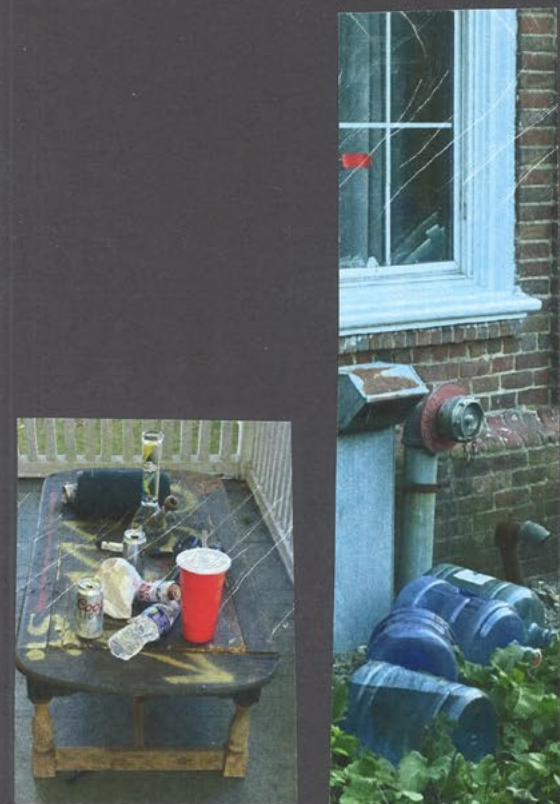





children (because Kayla + Emily would be mad if I didn't keep them first lol).

↳ Lastly, got to that time during recruitment (as [redacted]) when it was like 9:30 PM in Arizona + Sonya walked in with over 100

(b) insomnia cookies. I got to throw them out to sisters like Oprah giving away free stuff on her show. Like "you get a cookie", "you get a cookie!", "YOU ALL GET A COOKIE!" (jup we are thinking about that same gif of Oprah in red screamin' in) (even if you weren't [redacted] now you get my mental image.)

- If you didn't think this was going to be long then you obviously do [redacted] know me 😊 [redacted] has just given me the best years of my life, and with one year in [redacted] STILL left, I have shed tears thinking about not coming home to [redacted] next fall unless I don't graduate in May... then I'm back bitches **insert hair flip basic bitch emoji** To whomever / or whenever this is read, feel proud to be a part of this sisterhood, especially this chapter. You're real ones. Pour one out for [redacted] (we'll always have the highest panhell GPA - sorry to our neighbors over there in [redacted] 😊)

P.S. peace
luv + [redacted]
(my gift)

always +
day -- In like
Becca
[redacted] xoxo

For the past two years I have been a part of [redacted] attending the parties, supporting them through rememberable experier [redacted] eing friends with them all. I have always felt th [redacted] be nice to be a part of such a well established fraternity. This semes [redacted] the Brotherhood decided to have a pledge program for Little Sisters I thought it would be a great experiece to pledge and become a greek. Although I was friends with all the brothers before pledging, I have learned that a part of pledging is respect. The respect is shared between the Brotherhood and the Little Sisters as well as the pledges and pledgettes. I hope our pledgette class will be a foundation for all those to come and hopefully as Little Sisters we will keep the Brotherhood on its toes. I would like to wish the best of luck to the rest of the [redacted] pledgette class, Jennifer, Vicky and Sharon. Also I would like to thank them for all their support and enthusiasm from the scavenger hunt to cheerleading ([redacted] FOOTBALL IS OUR GAME !!) and through our hellish Hell night to come.

Most of all I would Like to thank Beth [redacted], my Pledge Master and friend. She helped me through the worst of it. THANKS! Of course I can not forget Laura and Bernadette for all those times they pulled the reins on Beth. Lastly, I would like to thank the brotherhood for giving me the opportunity to call myself a member of [redacted]

One pledgette project we had to do was write son [redacted] explaining why I want to be a Little Sister. I would like to end my new [redacted] with mine.

I WANT TO BE A LITTLE SISTER

Because:

- It is a g [redacted] friends.
- We can share good and bad times.
- We have someone to lean on.
- We have someone to gossip with, and someone to party with.
- We have a shoulder to cry on and a friend to laugh with.
- But most of all, we become members of [redacted]

Sincerely,

Pledgette Kerry [redacted]
"Sugar Stick - [redacted]"



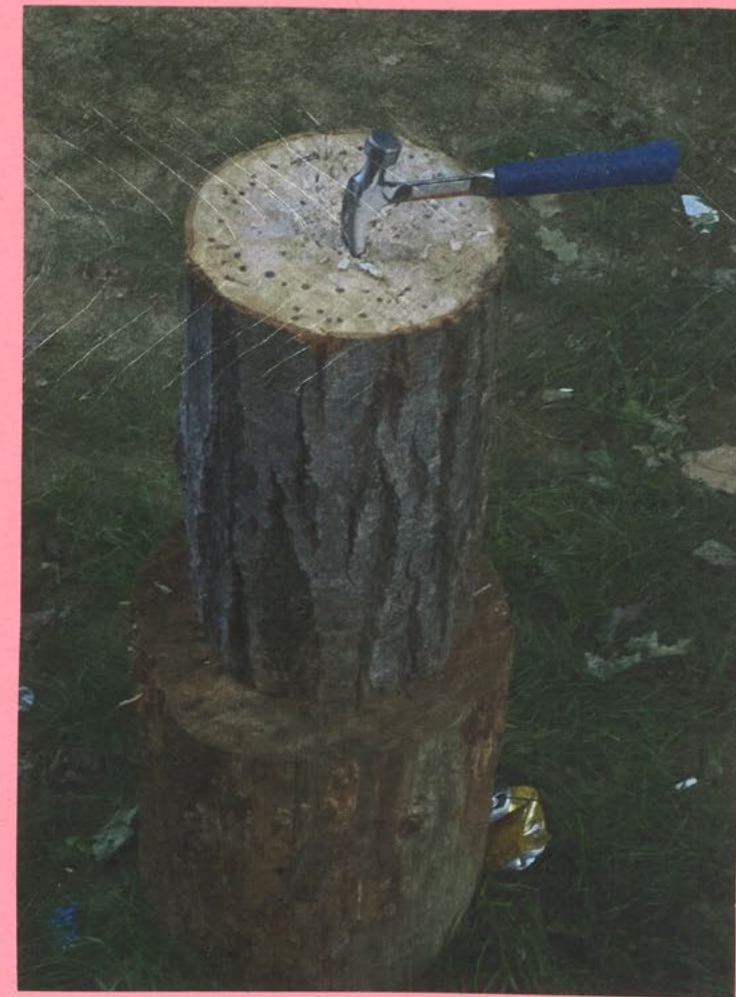
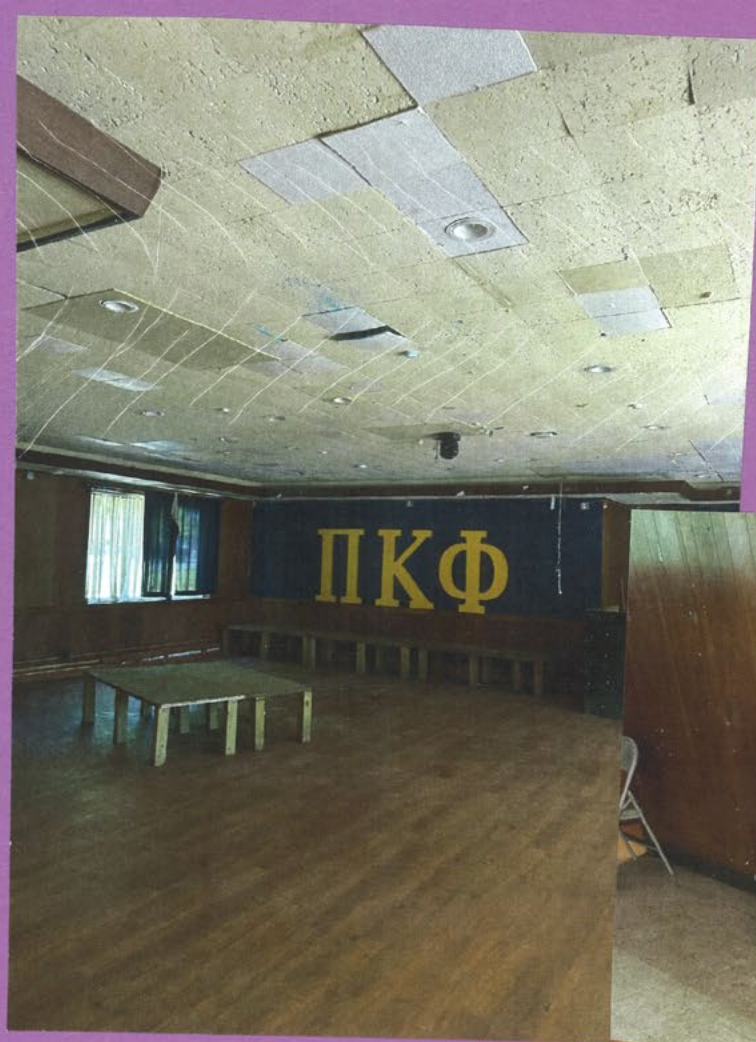

**** GREEK AWARDS BANQUET ****

FRIDAY

APRIL 8, 1994

*

6:00 P.M. RECEPTION

6:30 P.M. DINNER

7:30 AWARDS PRESENTATION

IN

THE GREAT BAY ROOM

THE NEW ENGLAND CENTER

MENU:

COFFEE RECEPTION

FRUIT PLATE

SALAD, HOUSE DRESSING

CHICKEN CORDON BLEU

CHEF'S VEGETABLES

RICE PILAF

CHEF'S CHOICE OF DESSERT

COFFEE, TEA, MILK

PASTA VEGETARIAN OPTION AVAILABLE UPON REQUEST

RSVP TO KELLY DUSSAULT, REBECCA DAKIN,

OR ANDY ROBISON

862-1001

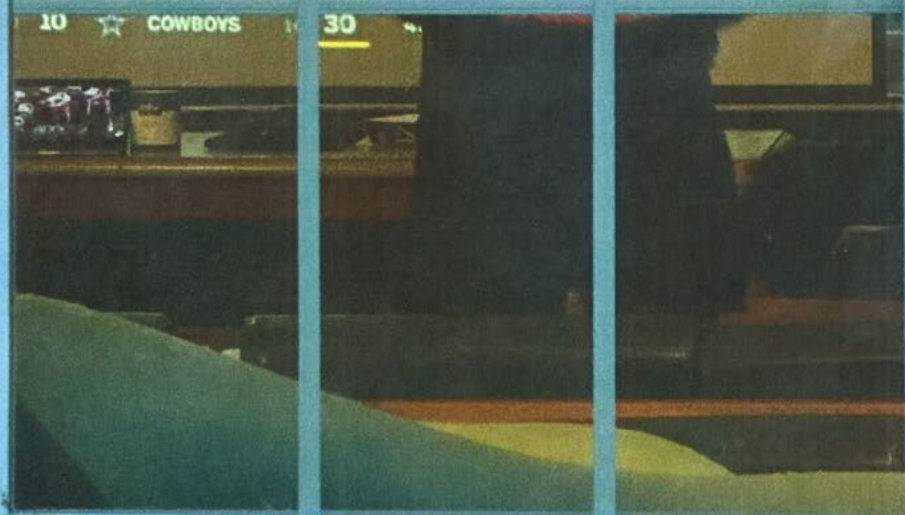

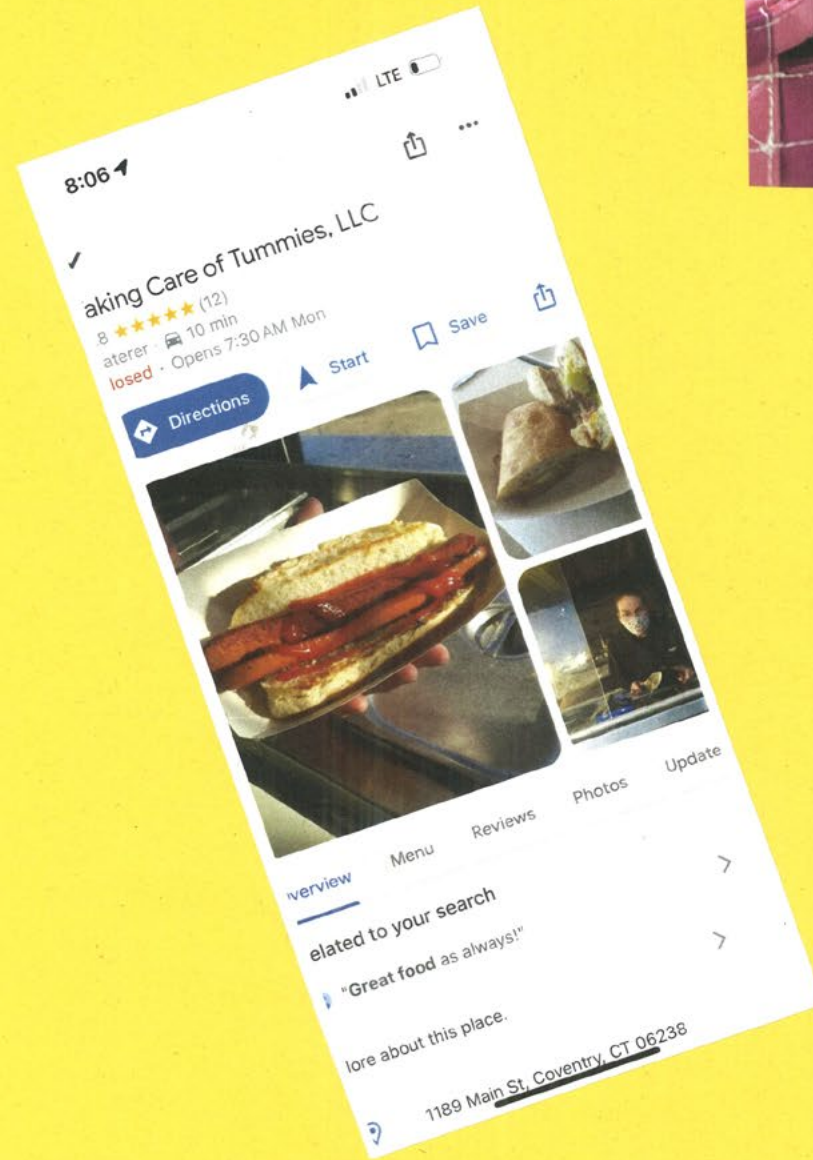
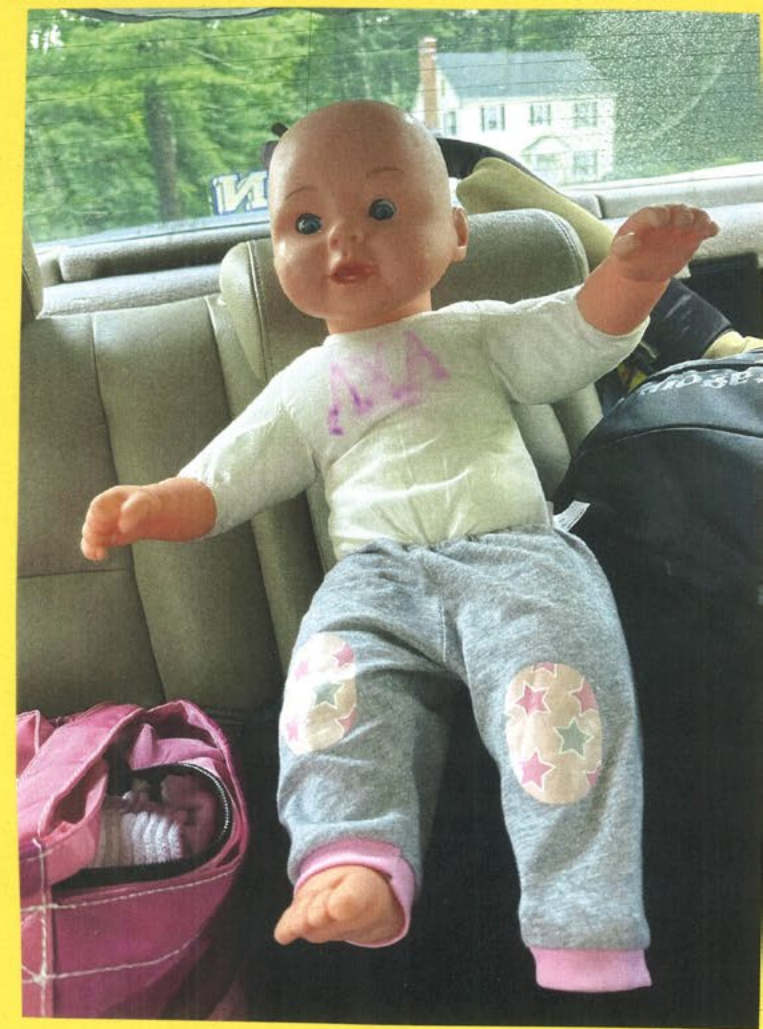

This is me and some of my sisters. I love them whenever I am low they always pick me up. This photo was from MISTKtau and my friends had a lot of fun. I have known these girls for only a year and they mean more to me than my friends that I have known for much longer. They are the first people I always text and go to when I need something. Love you all

CASSY

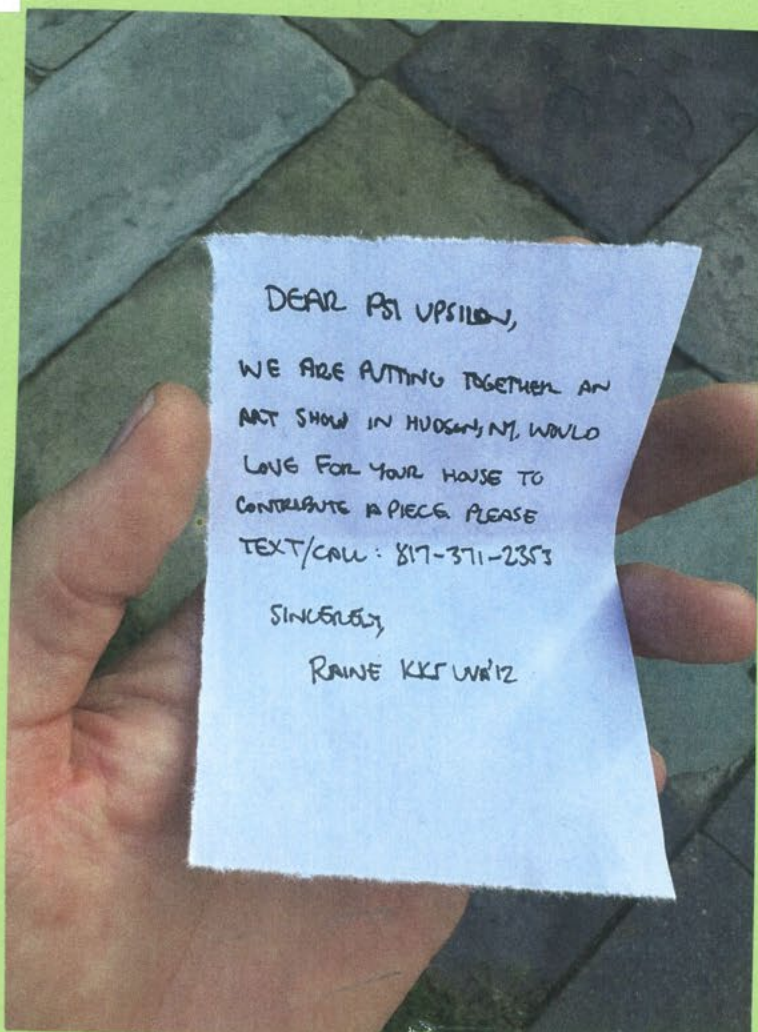

THE GREEK ALPHABET

Beginning with Phi Beta Kappa in 1776, secret societies have identified themselves with various combinations of Greek letters. These letters usually symbolize a secret motto or some other aspect of the organization. So that you may be able to identify the chapter of and other members of the Greek community on your campus, the following will prove helpful.



Opening and closing of letters

The proper salutation, when writing between brothers is "Dear Brother." The proper close is "Yours in the Bonds."

Pledge

A pledge is a prospective member who has taken the Founders' Pledge in a formal pledging ceremony.

Recruitment

The act of meeting potential members and introducing them to the Fraternity. A chapter should recruit new members year round.

Rush

A period, usually designated by a college or university, and often formal by nature where fraternities give bids to potential members.







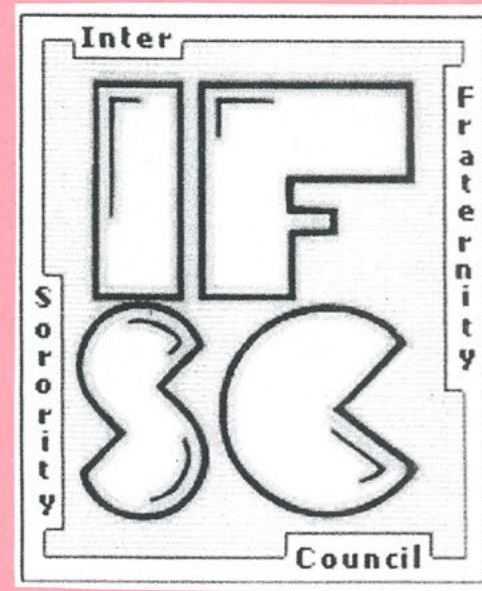

My favorite memory...

When I wrapped my big Jessie Lube on HBH 2015 ☺

- Bex

My [redacted] moment,
 I rushed when I was a freshman so being at [redacted] was an adjustment nonetheless, but going through recruitment and finding my "home" was even harder. However, my future Big who preteed me asked me to go get dinner/lunch not once, not twice, not 3x, but 500 many times. It was so refreshing to have an older sister [redacted] your side to vent to & to get advice from. She was my rock throughout my freshman year & I can't thank her enough. So basically I want [redacted] to always remember that [redacted] on older sister can EXTREMELY help the transition of new members. Without my Big, I don't know where I would be.

always, Amanda
 [redacted]

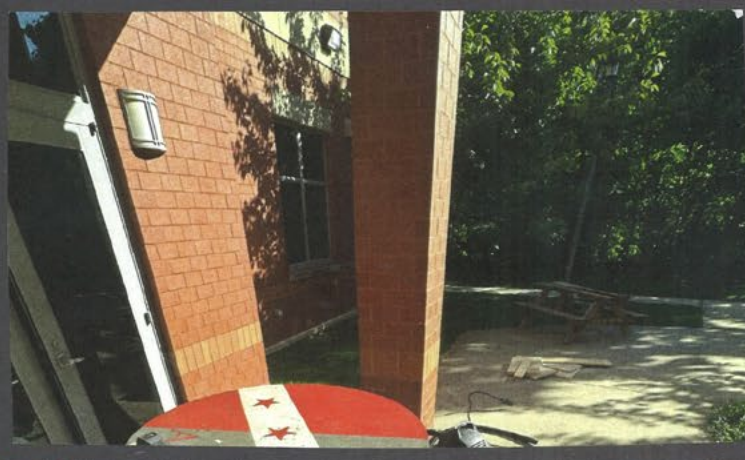

This is Joe [redacted], current Social director here to tell you we are partying our ass off (and we still have the 3rd highest house GPA). We now have ten deposit barrels, thanks to a midnight excursion at [redacted] and some good old fashion hardcore drinking. The 13th annual first day back party was a huge success, having mowed through six barrels in about 3 hours. The house just purchased a new regulator and tap lines, putting the quality of our beer better than most bars. Last work weekend we converted one of our three refrigerators into a kegulator ensuring the coldest beer on the block. Hope to see some of you at the Halloween party. Hugs and Kisses -Joe [redacted]



Courtesy shown to house guests
When a guest enters the chapter house, he or she should be greeted promptly and, in a very polite way, it should be determined who they are and how you can help them. A simple "Hello, may I help you with something?" will do. Remember, anyone entering the chapter house deserves the same respect and courtesy you would show them in your own home. As a general rule, a guest should be taken immediately to the person they want to see or asked to take a seat in the living room while you locate the person in question. Guests you do not know should never be allowed to wander through the house unattended by a brother.



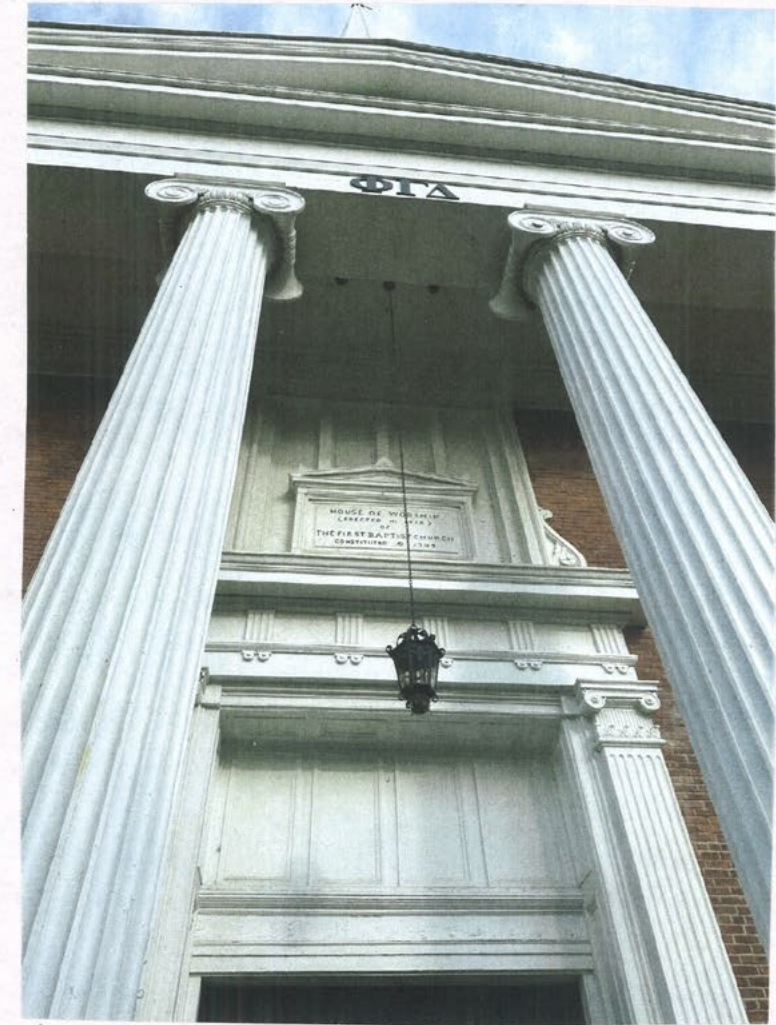

Email is not always the best method of communication. Sometimes communication may be of a sensitive or confidential nature and using email may be inappropriate or cause unnecessary hard feelings.

- Do not use email to broadcast confidential matters or discussions with third parties.
- Communicate complaints or dissatisfaction directly to the individual. Refrain from sending complaints about individuals to third parties via email.
- Communicate complex information through other means to avoid misunderstandings.

Remember that any email can become a public document very easily, despite the fact that you may send the message to someone privately.

Dear Future 9/13/17

Samuel Wilson
American meat packer



Samuel Wilson was an American meat packer who lived in Troy, New York, whose name is purportedly the source of the personification of the United States known as "Uncle Sam". [Wikipedia](#)

Born September 13, 1766, Arlington, MA
Died July 31, 1854, Troy, NY

Fast access to Google
Get the new Google widget [Get the app](#)

Q uncle sam wilson — Private

Send the right message
Target your audiences carefully when you broadcast information. Your intended audience will often influence your choice of language and style.

- Use clear and meaningful subject lines that your readers will understand
- Separate opinion from facts or other content in the message.
- Identify yourself clearly, using your full name for all but your closest friends or family members.
- Use an email address that is appropriate for your audience.
- Never insult or criticize via email.
- For mass mailings use the Bcc: field or do a mail merge.
- Limit the list of recipients and Cc:’s only to the people who are directly involved with the subject.

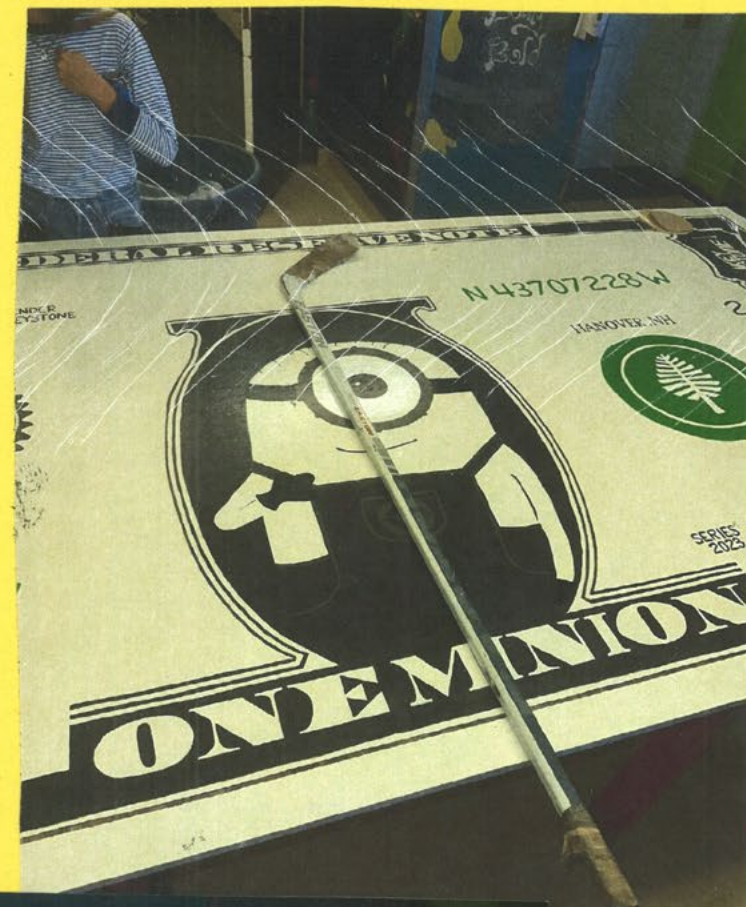
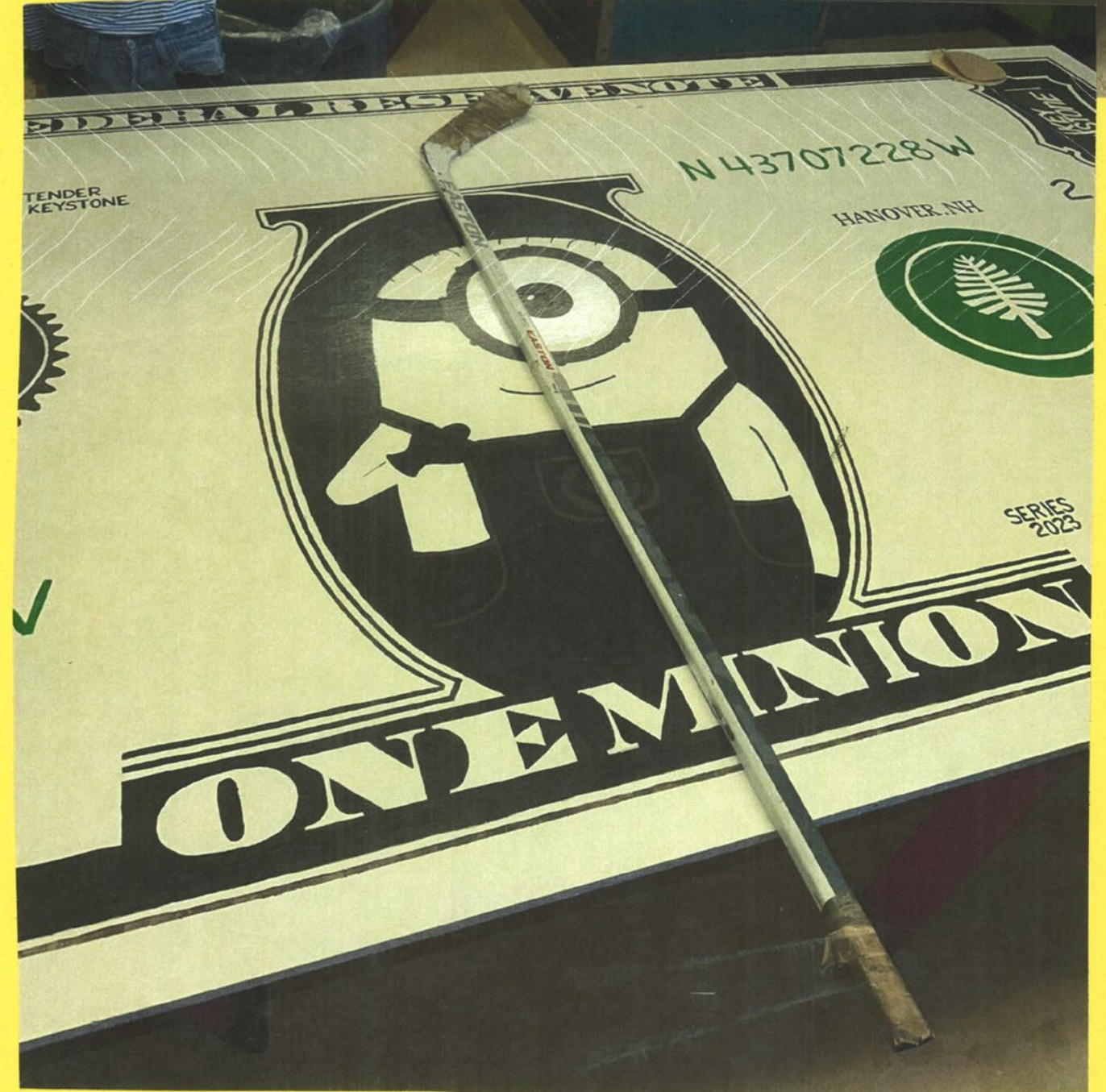

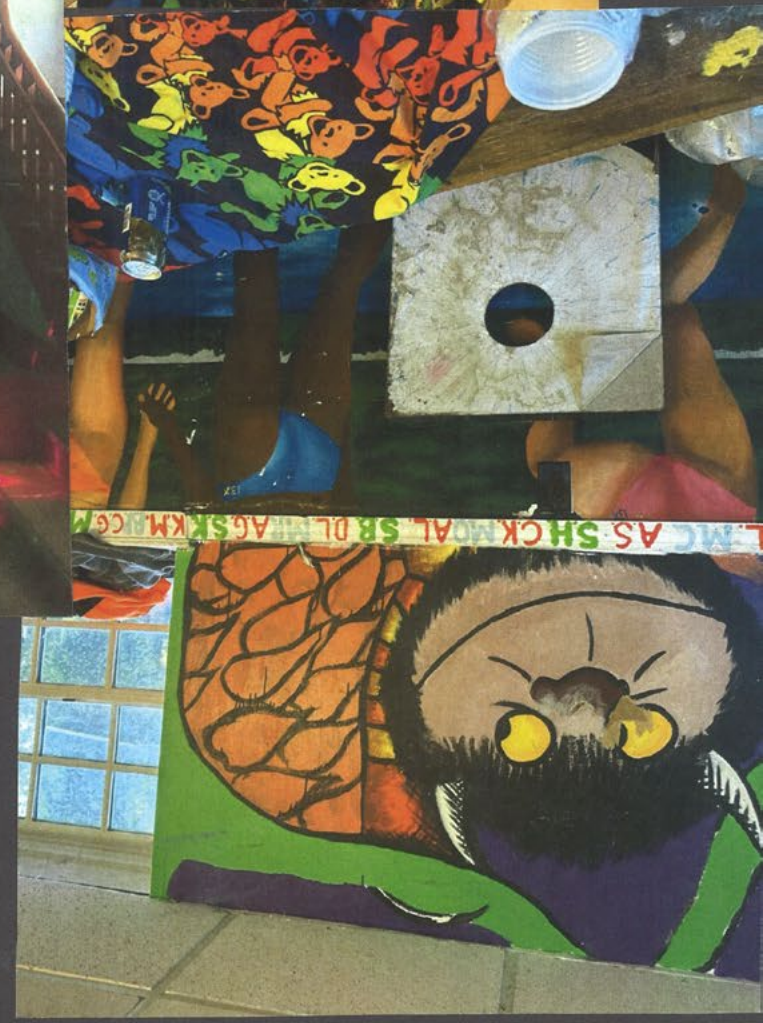
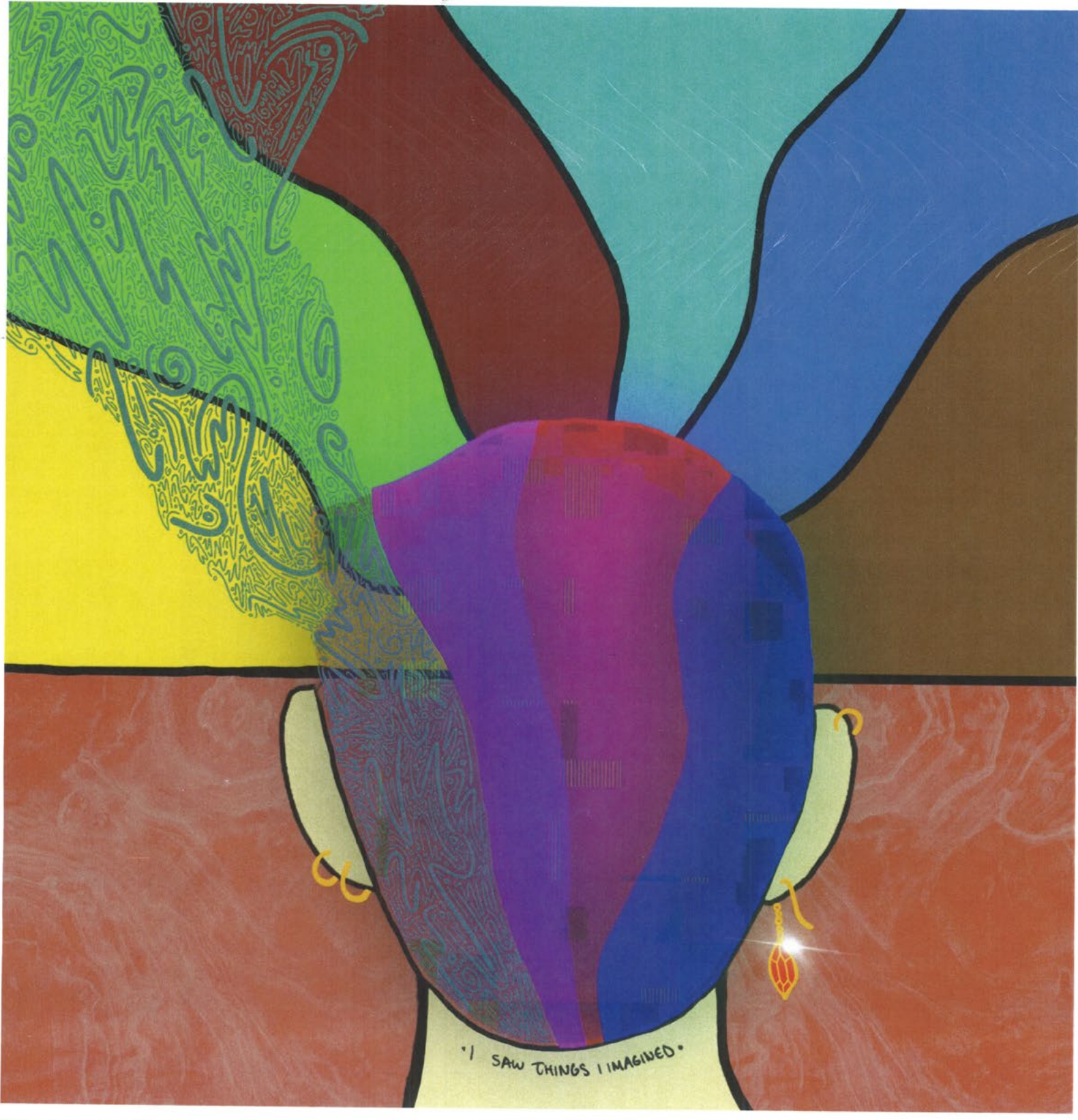

PLEDGEMASTER

10 brothers.

Dry rush.

Low finances.

The brotherhood has many obstacles to overcome before a successful rush is achieved. The last four pledge classes have yielded an average of two or three active brothers. With this current rate of growth the brotherhood remains stagnant. The standards of [redacted] will be maintained but there is a problem in progress; to turn [redacted] into something more than what was passed down to us. We are all very young, the majority of the house being sophomores, and we have a lot to learn about [redacted] ourselves. In the face of these adverse conditions, the spirit of our house remains strong and each member feels very optimistic about fall rush. Our goal for rush will be the same as it has always been: quality brothers. The standards of the pledge program will not be adjusted to meet a quota. In fact, with a downsized house, each of us has had more contact with pledges and rushees, consequently forming very accurate opinions about each potential member; the quality is improving. The house is straining in hard times but there are positive things coming out of it. The quality of our new members and immediate responsibility as officers our molding a brighter future.

Please call me at [redacted] for a schedule of all the events and for input into how to attack dry rush. For now, jot down this list of major events:

- August 29th, Rush starts.
- September 23rd, Bids.
- September 29th, Inductions.

The canoe trip was a lot of fun and I'm hoping to see most of you again at the picnic. And to those Alumni that have just left [redacted] last month, Zoul, Spooze, and Spleen,—congratulations and enjoy the other side, but you're not done yet, warm up your checkbooks!

Fraternally yours,



"Creampuff"

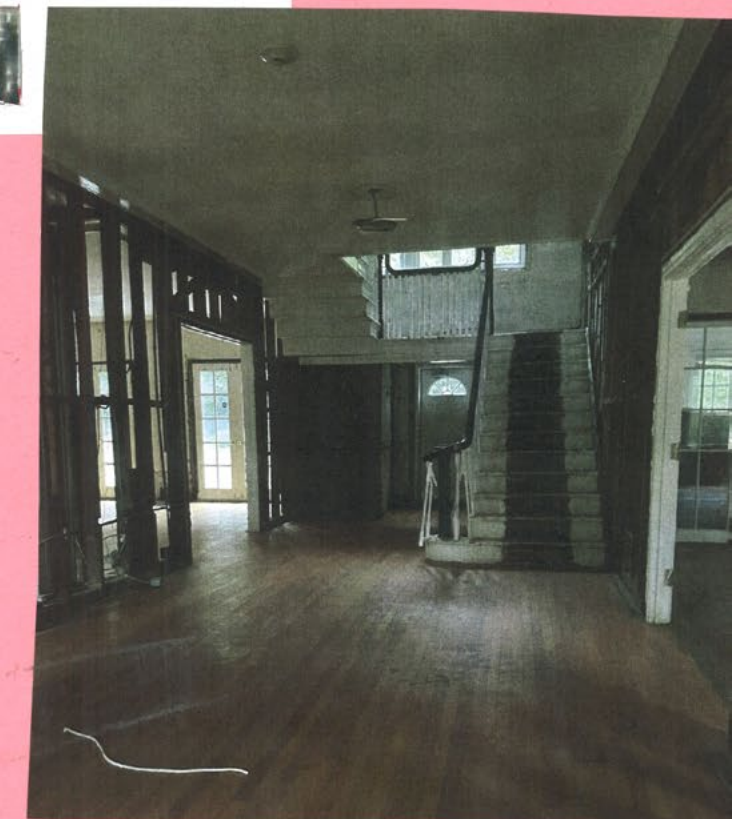

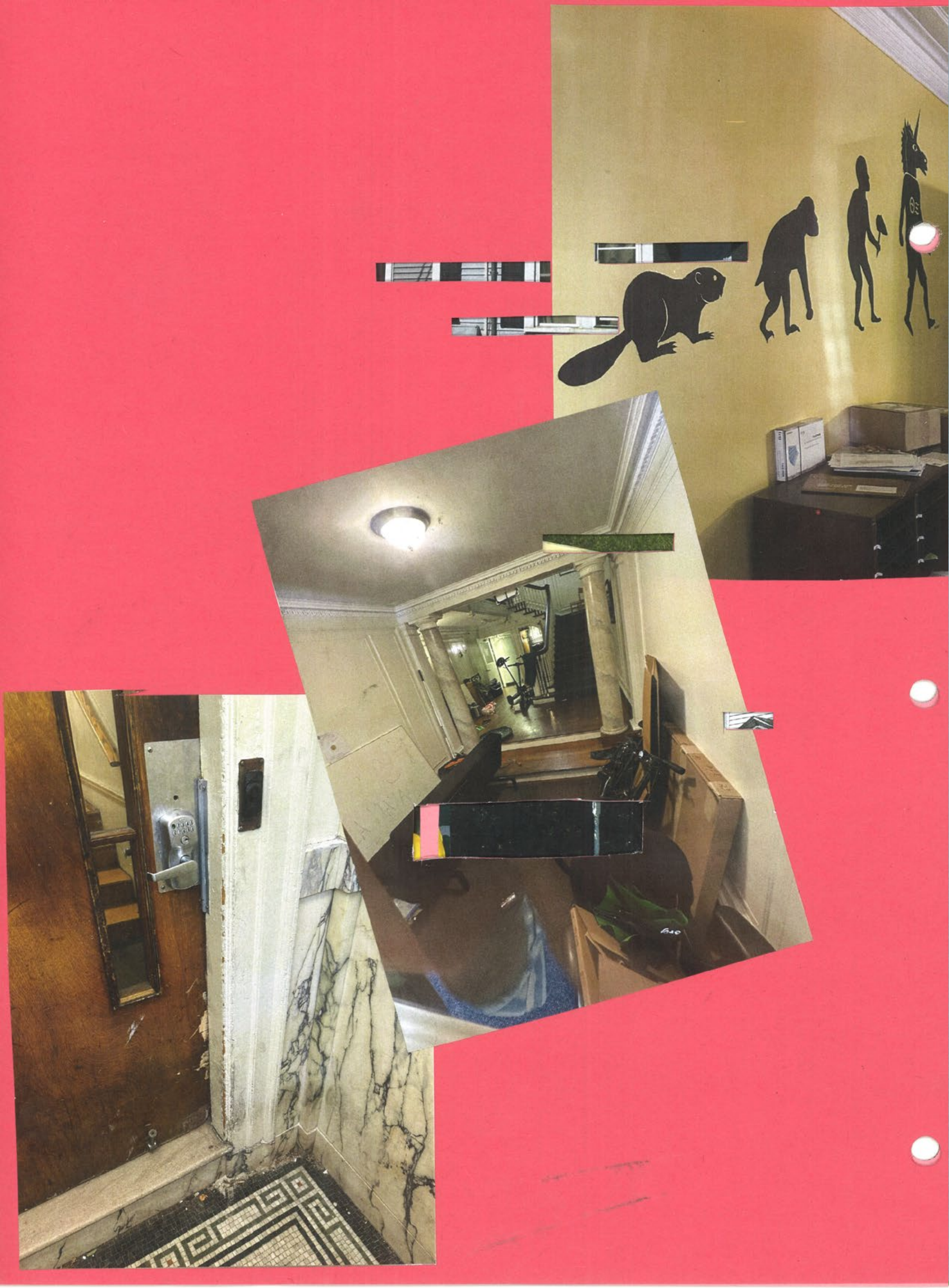



Email Etiquette

Internet technology has made it possible for people all around the world to communicate with each other in meaningful ways, whether for research, education, business or enjoyment. With concerns ranging from privacy, security and freedom of speech, to honesty and confidentiality, it is more important than ever to understand and observe general guidelines of email etiquette.

In many cases email takes the place of business correspondence and should be written with the same care that you would take if you were to print the letter on formal stationery and place it in the mail. Follow these tips to communicate professionally with others.

- Common courtesy is required in written communication.
- Return email messages promptly even if only to acknowledge receipt of the message.
- Use an appropriate greeting for each new subject email. A greeting like "Hi, John" should only be used with informal messages to friends.
- Never copy or forward a message or attachments without the author's permission.
- Use "request delivery and read receipt" only when absolutely necessary. Ask for a response from your reader within your email message.
- Avoid offensive language of any kind. Since it is very easy to forward your email without your knowledge, you must assume it will be.
- Proofread your message, use spell check and then proof your message again.
- Use capitalization and punctuation in the same way that you would in any other document. Do not use all caps or all lowercase.
- Use tools to quarantine viruses and manage spam.

Effective email messages

- Start with a strong subject line.
- Include the most important statements in the first paragraph followed by supporting details.
- Use sub-topic headings within your email message.
- Ask for action. For example, let your recipient know what you need in order to complete a task.
- Use spell check, consult grammar and style manuals and proofread your messages.
- Re-read your message one last time before you send it.

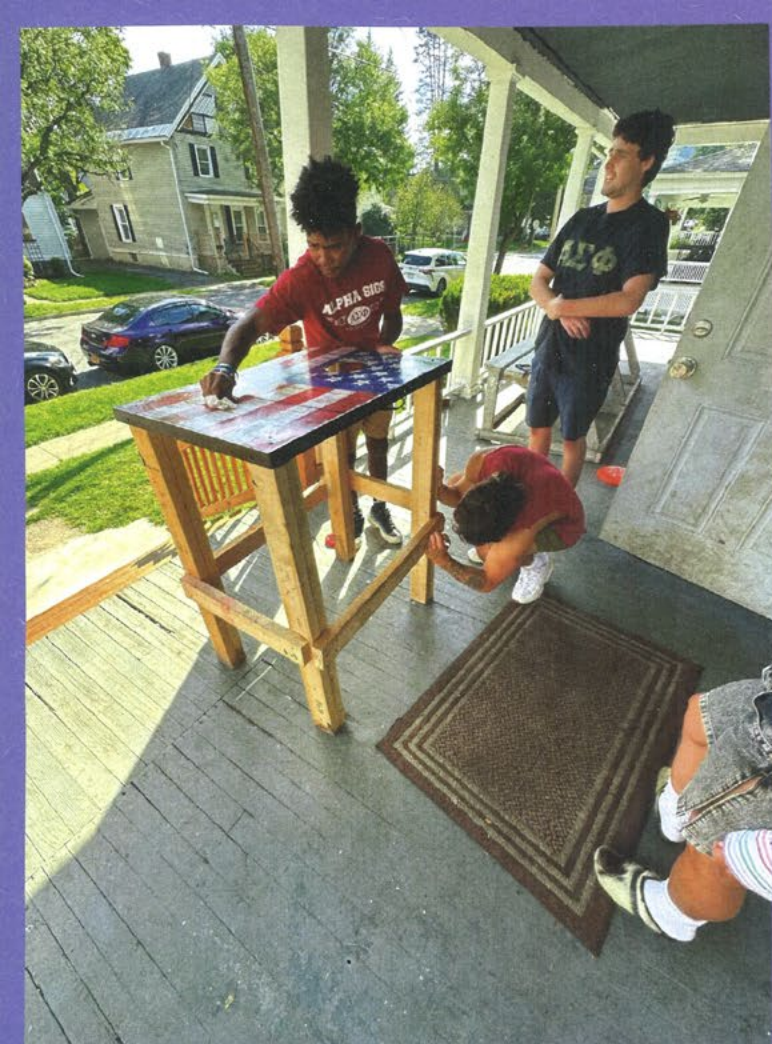

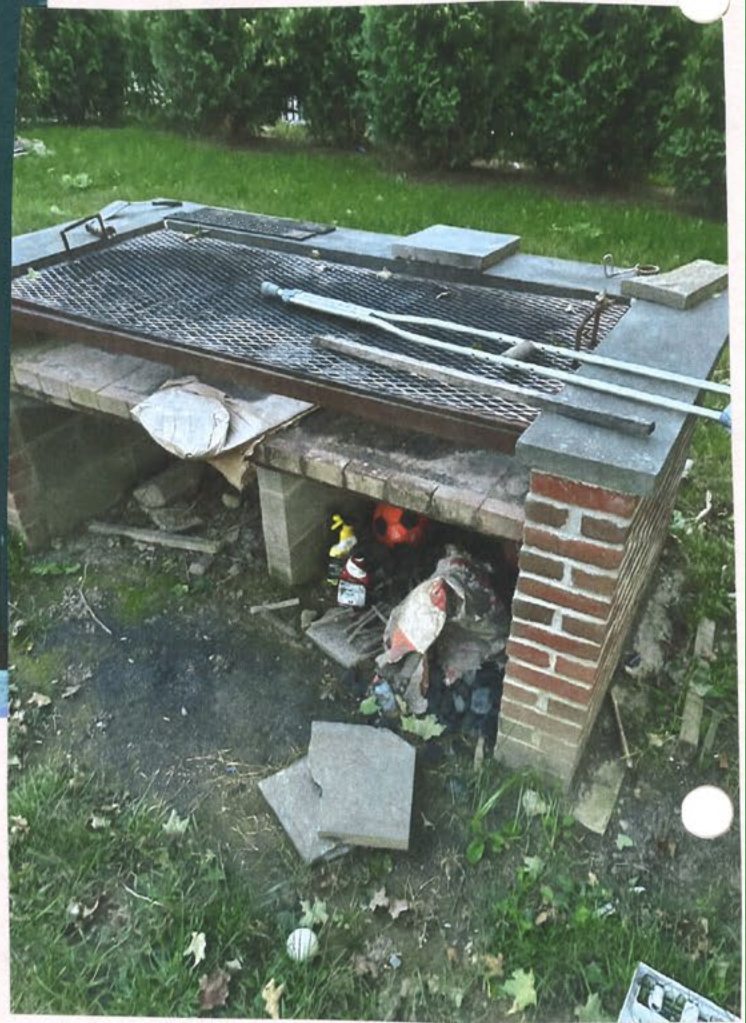
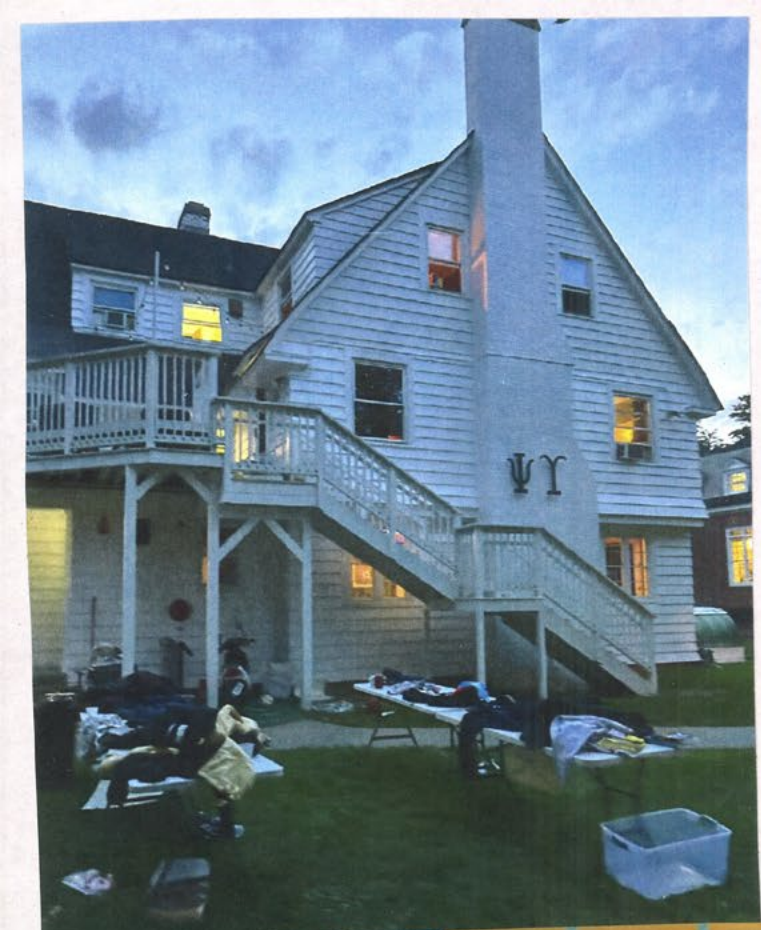

Giving and accepting compliments

There is an art to giving and accepting compliments and it's a talent that you can easily learn. Compliments should always be upbeat, sincere and result in a smile. When you are given a compliment, never disagree with something nice that is said to you or about you. Any hesitation, even when caused by modesty or embarrassment, calls into question the judgment and good taste of the person making the compliment. Your answer should be a simple "thank you."

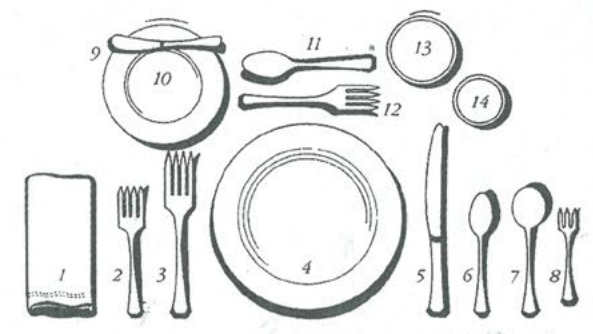

FORMAL DINNER SETTING: 1. napkin; 2. salad fork; 3. dinner fork; 4. service plate; 5. dinner knife; 6. dinner spoon; 7. soup spoon; 8. seafood cocktail fork; 9. butter knife; 10. bread plate; 11. dessert spoon; 12. dessert fork; 13. water glass; 14. wine glass.

head of the table, passing each dish from left to right. Ladies and guests are always served first.

Silverware is placed on the table in the order in which it is intended to be used. A simple rule of thumb is to always start on the outside and work in towards the plate. Since the salad is served first, the salad fork (smaller) is located on the far left. The soup spoon (largest) is located on the far right.

There are two basic styles for the proper use of silverware: American style and European style. In the American style, food is cut while holding the fork in the left hand (tines facing down) and using the knife with the right hand. Once the food has been cut, place the knife on the plate, switch the fork to the right hand (tines facing up) and begin eating. For European style, the fork remains in the left hand (tines facing down) and the knife in the right hand throughout the meal. Food is conveyed to the mouth with the fork. You can look to your host or hostess for guidance. When you finish eating, used silverware should be placed on the dinner plate and not on the table. Place a soup spoon on the plate under the soup bowl. Your napkin remains on your lap until you have finished the entire meal, including dessert and coffee; when using it, keep in folded so that any food on it is concealed, then gather it together to place neatly to the left of the table setting—never on the plate. If you must get up during the meal, place your napkin on your chair, not on the table.

Drinking alcohol

At any event where alcoholic beverages are served, and where you choose to drink, you must be able to handle yourself and to be in control of your actions. Remember that you do not want to embarrass your host; further, you

on the meal being served and begin conversation. Your goal is to appear to be at ease, and in complete command of your situation.

Before taking a seat, look to the host or hostess for an indication of where to sit at the dinner table. Don't take your seat until the guest of honor and all of the ladies present have been seated. Lunch-size napkins should be folded in half and placed on your lap. Never tuck your napkin in your shirt. For small dinner parties, everyone should wait until the host or hostess has been served and has picked up his or her fork before beginning the meal. For large dinners, you may eat as soon as you are served, particularly if the first course is hot. As a rule, food is always served from the left and removed from the right. Beverages are served and removed from the right. If the food is located on the table, service should begin at the

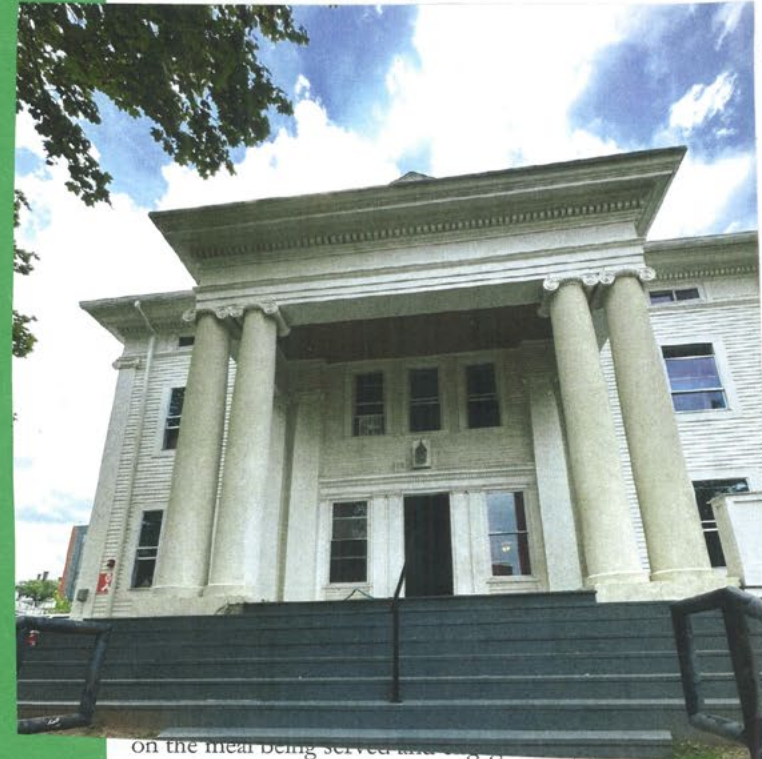

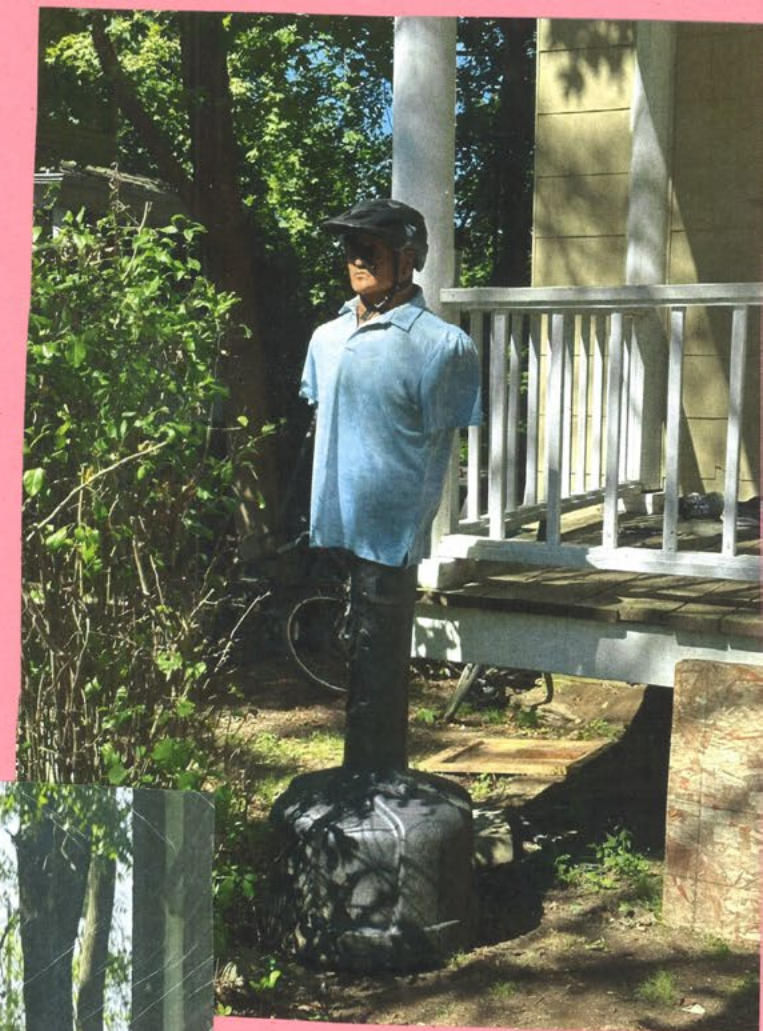

Also, our PARENTS DAY affair this past semester was a tremendous occasion for all parents—especially Mrs. Mihalik. Every parent was greatly impressed with the appearance of the house. Noticing the fact that we repainted the front of the house, re-constructed the hallways, renovated the library, re-waxed the front room floor, and [mostly] completed the soffit above the bar.

On a more important note, [redacted] is faced with an extremely critical Fall Rush. As most of you are probably well aware, it is imperative that we acquire a good number of quality brothers. Currently, the executive officers along with brotherhood input are intelligently planning events and developing some innovative ideas for this fall. It would be extremely helpful if a lot of alumni would stop down —(especially at events)— to lend us a hand with "entertaining" prospective pledges. In short, the motivation, perseverance, and tenacity of every one of our ten active brothers will yield the quality pledge class we desire.....Alumni support can help.



Fall '11's 1st night
in the house ♡
shotgunning beers
in the shower
-steph T, Meg C,
Kim D.



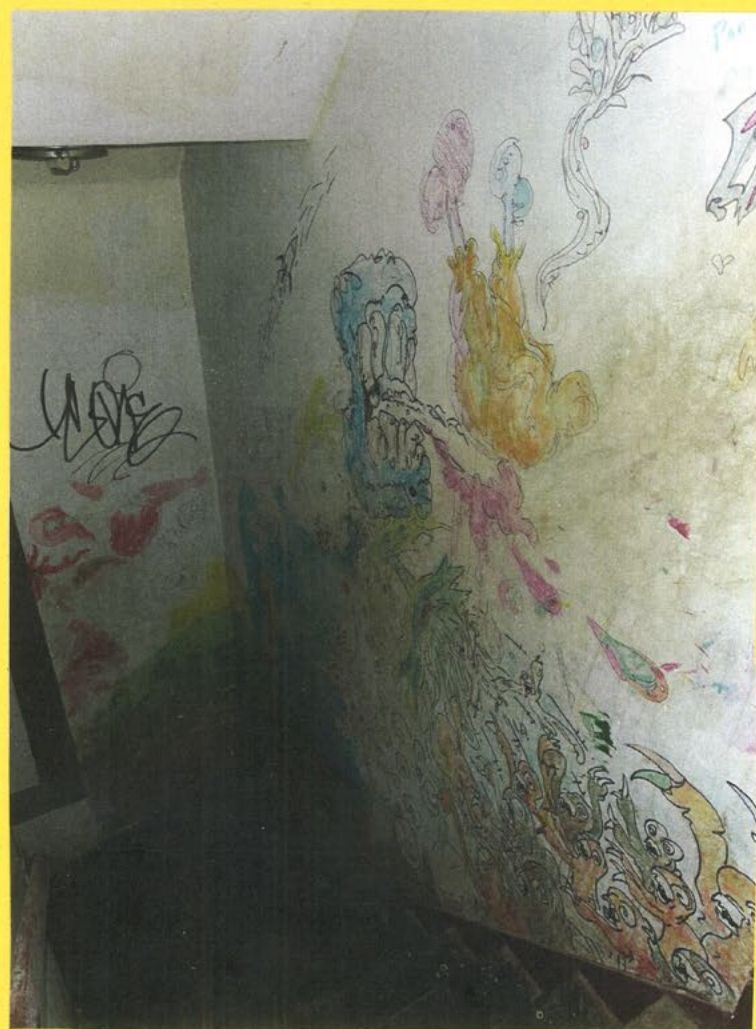

1. Pledge the House for a minimum of six weeks.
2. Pass all pledge tests (one per week).
3. Have all the Active Brothers' signatures in the pledgebook.
4. Pass through two blackball sessions, one at the end of three weeks and one just prior to initiation night.
5. Submit an approved pledge paddle (approved by the Pledge Master and the Big Brother).
6. Pay the \$65.00 pledge fee.
7. Should have a satisfactory GPA for the most recently completed semester.
8. Complete a House project assigned by the House Chairman.
9. Complete a community service project.

If a pledge cannot meet all of these requirements, he will become an inactive pledge and will be under the control of the Pledge Master.





Hi! I hope you LOVE [redacted] so far. My name is Clarey, I'm from Fall [redacted]. Today I hung out with Marina Harris she's so cool. My big dropped (boo) but I got an unofficial foster big (yay!) and she's literally so cool. Last year I slept on Shelby & Hannah's floor for a solid week when I got in a fight with my roommate. I honestly don't know what I'd do without them. Our bid day theme was MERMAIDS! My [redacted] advice to you is to NEVER stop making friends in [redacted]. This is my 2nd year in [redacted] and I just met so many people this semester and they're all amazing. I'm writing this from a Junior Panhellenic Council meeting and all my panhel friends are awesome. I really hope I get a good little [redacted] I really hope you cherish your time in [redacted] because it's honestly the best decision I've ever made. Have a WONDERFUL time!

If you find this, PLEASE send a picture to [redacted] AND [redacted] in [redacted] requir [redacted] Pledge Master. Clarey







Profanity is never appropriate in public situations. While you may think the chapter house is a fairly private place, remember that your brothers have guests over, often when you don't know guests are present. You can imagine the offense guests take when someone uses foul language or shouts out an obscenity in another room.

When the visitor happens to be a [redacted] alumnus, the guest should be treated with all of the respect you would give any active member of the house. Because the alumnus is an older brother, he has just as much right to be in the house as you. Try to utilize this opportunity to learn more about the chapter's history by taking the alumnus on a tour of the house and asking questions about what the chapter was like when the guest was an undergraduate.

Telephone manners

The manner in which the house telephone is answered should be concern of the entire chapter. If it is allowed to ring for a long period of time, or if the person answering has a "what do you want" attitude, it creates a negative image that reflects poorly on every member of the chapter. When someone takes the time to call, it is usually for a good reason and it is good manners, as well as common courtesy, to answer the telephone promptly (by the third ring) and to give the caller your undivided attention. Your voice should be warm and friendly, and your diction clear and precise.

If you share the telephone with others, be considerate and limit the time you spend in conversation, especially if you do not have the call waiting feature to let you know if someone is trying to make an incoming call.



Savannah,
Who knows when you're reading this. It may be a year, two, five... you are definitely in a new place in your life. Congrats! I hope [redacted] has found meaning in your adult life post-college. Remember why you joined [redacted] - being 1st gen you've now created a legacy for Kyleigh & Madison (as well as my future daughters). You didn't join for a person - you joined for the philanthropy and the feeling. Being a member of [redacted] is being a part of something larger than yourself. I hope you are continuously building strong girls by being a strong woman. I hope you push yourself out of your comfort zones & keep in contact with those who matter to you - like Monica, Nikki, Samara, Sam, Jill, Marissa & everyone else. If you miss them and haven't spoken to them - REACH OUT. You are sisters for life. Continue to pursue yourself fearlessly and find what makes you "you." Know your sisters help directly & indirectly shape the woman you've become today.

In like (or whatever that means),

A

ests take when s
an obscenity in

ther, he has just as much right to
. Try to utilize this opportunity to

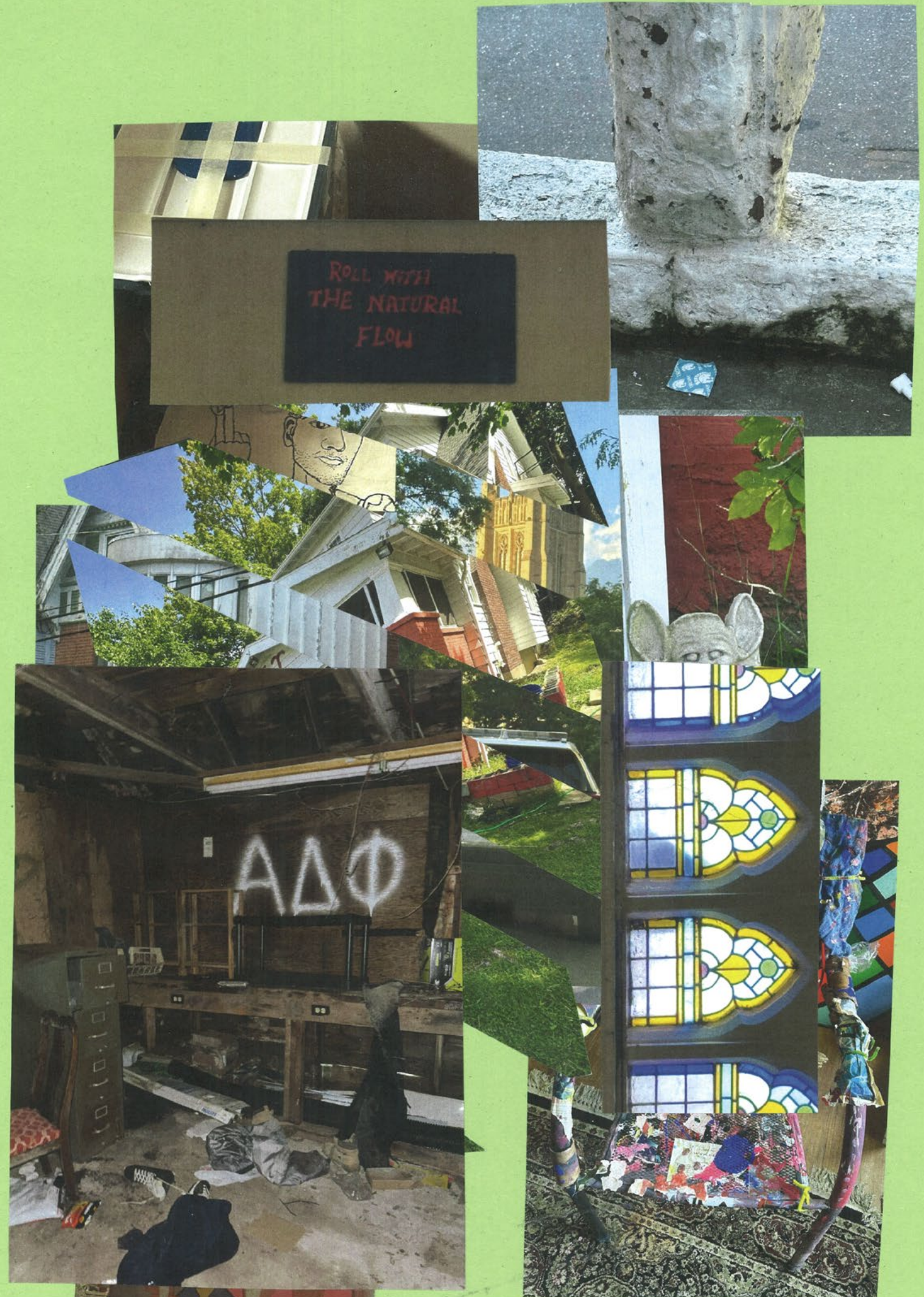



This is Dave the house chairman telling you everything is Jim dandy. With the installation of urinals in every room there is no longer any need to piss on the floor. The lack of a roof allows the third floor occupants to take shower every other week. The house over all is in terrific shape. Another layer of floor in the

kitchen has finally made it party proof. Small additions in the back yard such as a patio in front of the grill and a motion light have turned it into a marvel of modern science. Current projects include renovation of the basement into a more livable space and the possibility of converting the front room closet into a bathroom. So, if anyone has anything they need to rid themselves of we would be excited to help you out. Couches are in high demand but a urinal or toilet, bar stools, and wall decorations are greatly appreciated.

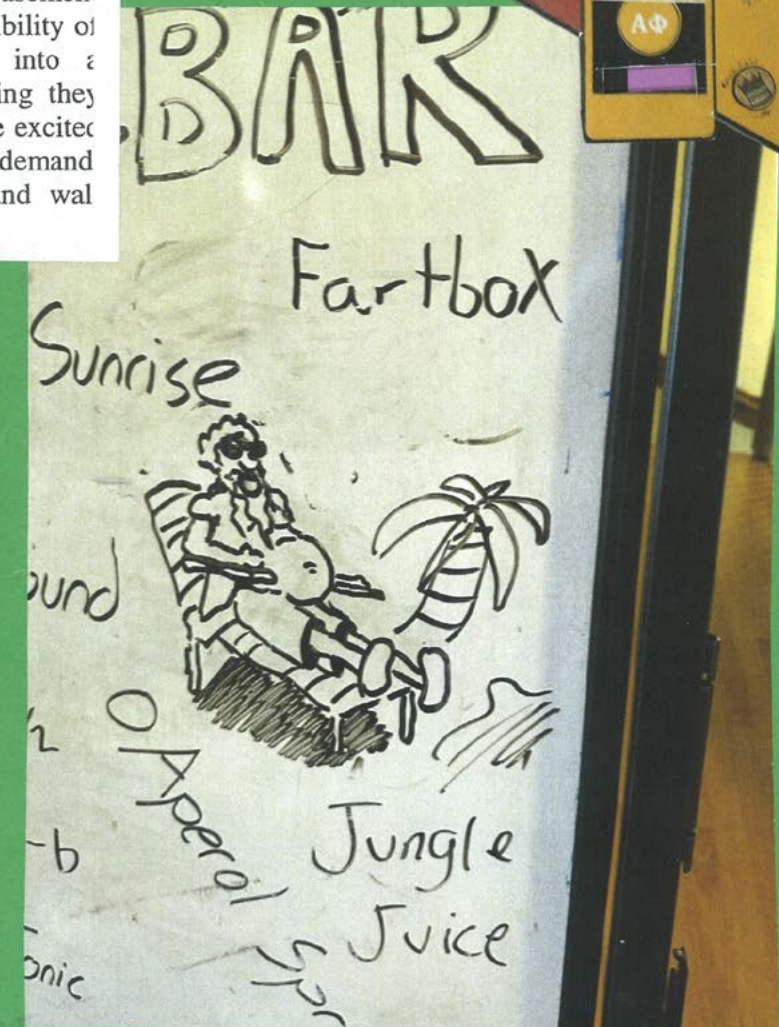

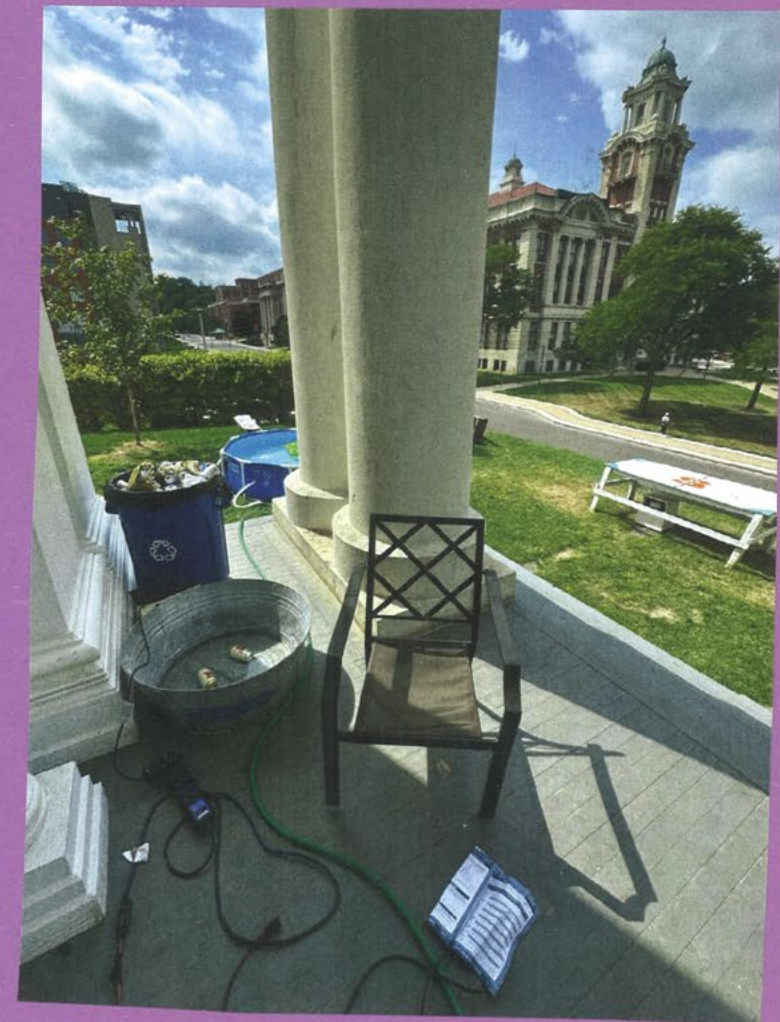

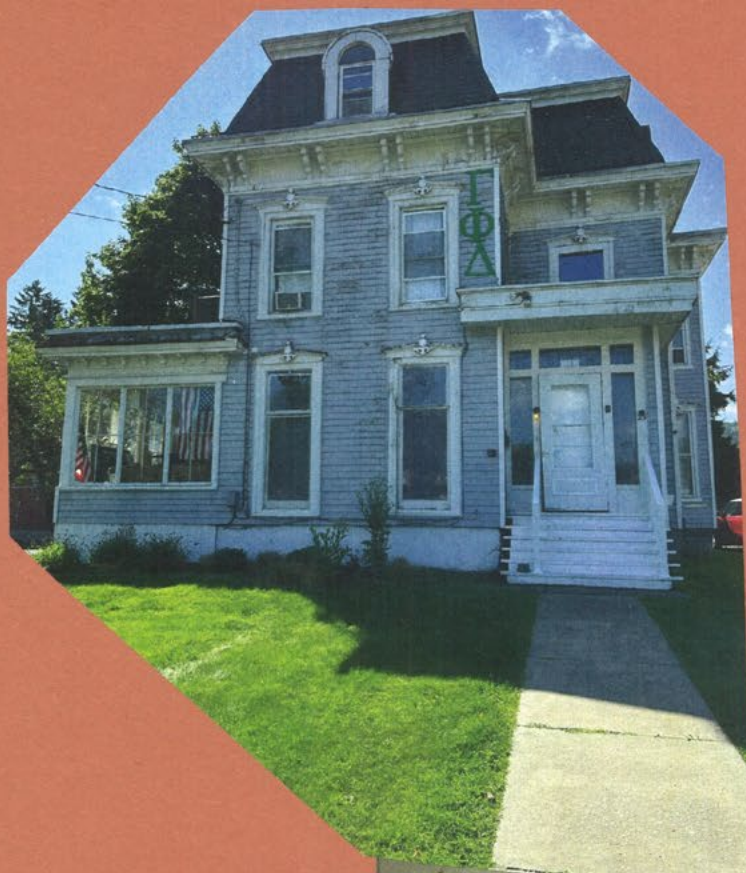

ETIQUETTE

Much of your success in life, whether it be personal, social, or professional, depends greatly on how well you get along with others. Therefore, it is in your best interest to learn about the way society expects you to behave and interact with others. Remember, people want to be around others who are intelligent, considerate, and thoughtful; no one wants to deal with someone who demonstrates poor manners.



do not want to embarrass yourself, for many eyes may be watching.

Keep in mind that one 12 oz. beer containing five percent alcohol, one 5 oz. glass of wine containing 12 percent alcohol, one 12 oz. wine cooler containing five percent alcohol, or one 1.5 oz. shot of distilled spirits containing 40 percent (80 proof) alcohol all have the same amount of alcohol, and the same effect on you.

Don't hang around the bar; participate in the event instead. Order nonalcoholic beverages between alcoholic drinks; hosts offer soda, fruit juices, tea and coffee. It is never impolite to refuse an offer for a drink. A simple "no thank you" will suffice.

Proposal of "Little Sister" Program

- ① We feel that the little sister pledges should take tests - These tests would be: Greek Alphabet, History Test, & Signature Test
- ② We feel they should get signatures from both the brothers and Little Sisters - These signatures should not be taken too serious
- ③ We suggest a brotherhood dinner
- ④ We also suggest a Little Sister event where all the new Little Sister Pledges will go out with the Old Little Sisters in order to get to know each other
- ⑤ A small Blackball just entailing a "dance" which we were required to do in front of the brothers
- ⑥ They should have the same green pen and Pledgebook
- ⑦ We'd like to hold meetings every week during pledging and afterwards in order to keep the "Little Sisters" as a unit even after pledging is finished. These meeting may or may not take place at the fraternity.

Basically what we'll do is talk about things and functions which we will do for the brotherhood. We will also prepare the new little sisters of what is expected of them when we leave at the end of this year

⑧ This Spring Semester ahead we would also like to start official rush for "Little Sisters" if that is the motive of the brotherhood. Unless your just planning to keep these new girls till they graduate (where you'll be in same position as you are now) We believe it should be continued each semester

⑨ We feel program should start this Monday, October 24 and end approximately December 5. This time limit takes into account the opportunity to get to know the brothers, get the signatures, and learn something about the house

* Please remember they are pledging to be "Little Sisters" and not brothers!

Submitted by:

Beth
Laura
Bernadette

With the "reins" of Dry Rush strapped to the shoulders of "The [redacted] House," and an aging house dog with one paw in the grave and the other as our future tap handle, [redacted] is still running strong. With only ten active brothers, we managed a respectable third place in Greek Week last spring. Also, every committee up at IFSC is chaired by [redacted] brother. Our annual Summer Picnic was a great success with a descent turn-out, great weather, and a pleasant visit by Ronald [redacted]...not to mention the fornication taking place in the shrubbery.

Thanksgiving is just around the corner, and so is the Dinner Dance. As many of you probably know, last year's event was a BLAST!! and this year's looks just as promising, if not better! Dinner Dance [redacted] will once again be held at DON PEPE'S RESTAURANT on McCarter Highway here in Newark, on Friday November 26th from 6-12pm. (the day after Thanksgiving). A copy of the menu is enclosed. The price per plate is \$50 and \$100 per couple. For those who wish to attend, please send a check to the house (ATTN: Tracy) or call me at [redacted] in order to notify Don Pepe of a accurate head count. Also, state with whom you would like to be seated with during the evening's festivities.

The morning following the Dinner Dance will mark yet another alumni/brother football game. Despite the fact that the alumni took a major beating last year, I hope to see a lot of alumni present. A few weeks before the Dinner Dance, there will be an ALUMNI HAPPY HOUR on Friday, November 12th from 7:30--??, which should be a fun time for all!

On another note, This year's infamous Halloween Party will be held on Friday, October 29th. 98-Proof will be jammin' all night, so don't forget to wear your costumes.

I would like to thank Frank [redacted] and Rich [redacted] for their generous donations, especially in our time of extreme poverty.

Important note: The Dinner Dance is coming quick, and due to our financial situation, your prompt payment is extremely imperative in order to secure your spot. We are looking forward to seeing you very soon.

Fraternally,

Tracy
President





to get to know
s, and learn

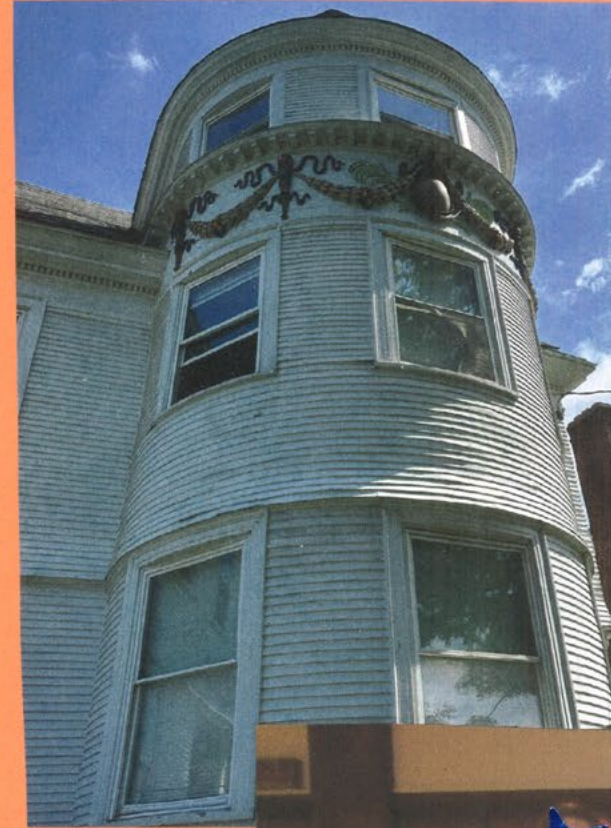

Four weeks of torturing freshmen with Fatboyee's secret hot-wing sauce, dorm-storming, and ice-tea parties, have yielded four eager young men ready to learn what [redacted] stands for. Although four appears shockingly small for a pledge class to start off with, it is in agreement with a dry-rush environment. Previously, those pledge classes that boasted 15 to 20 members usually produced only a few brothers. These handful of pledges that were inducted were aware early in the program that there was more to the [redacted] than power hours (now history) and a wallyball court; *that's* what got them through. For prospective of a dry rush, it is very much the same concept. The veil of alcohol lifted, they see the brotherhood in its raw form: strong and close. If you're unsure of their faith, come meet them yourself on the following dates:



Name			
A			
B			
Γ			
Δ			
E			
Z			
H			
Θ			
I			
K			
Λ			
M			
N			
Ξ	xi	zeye	
O	omicron	oh - mih - kron	
Π	pi	peye	
P	rho	roh	
Σ	sigma	sig - ma	
T	tau	taw	
Y	upsilon	yoop - sih - lon	
Φ	phi	feye, or fee	
X	chi	keye	
Ψ	psi	seye	
Ω	omega	oh - may - gah	

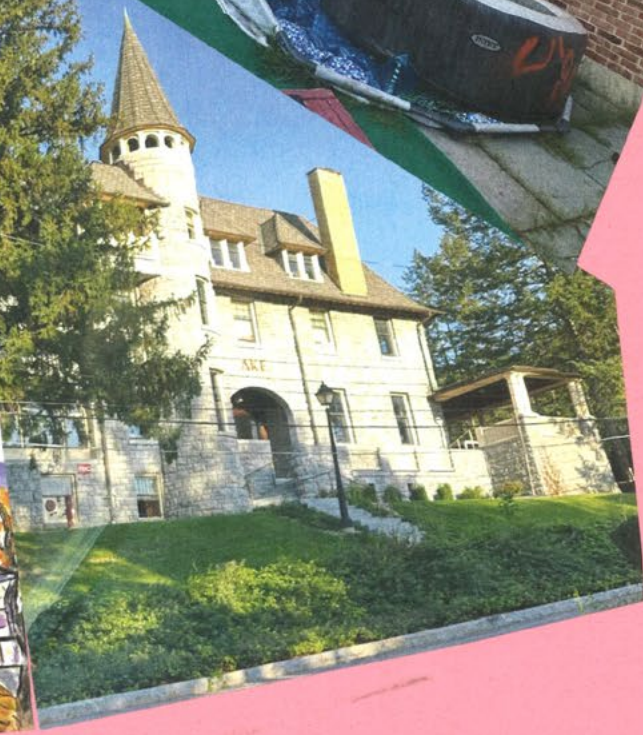
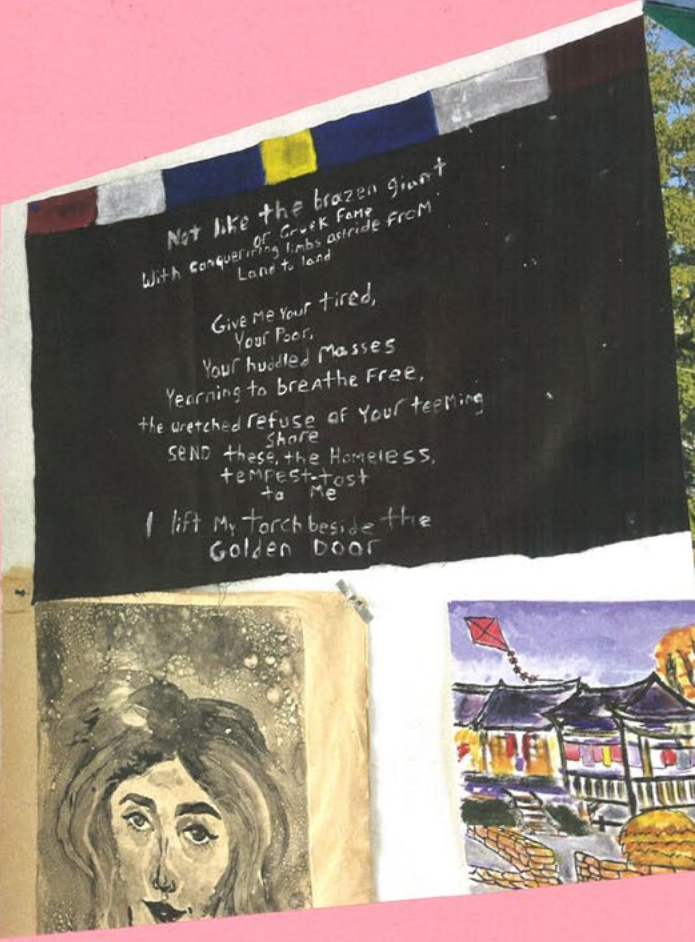
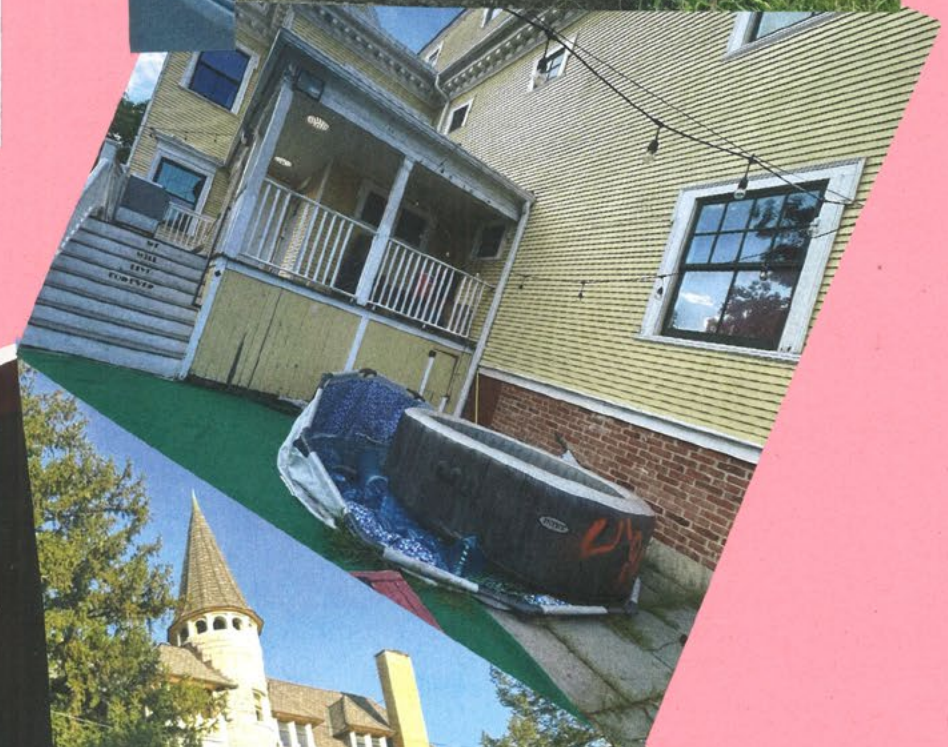
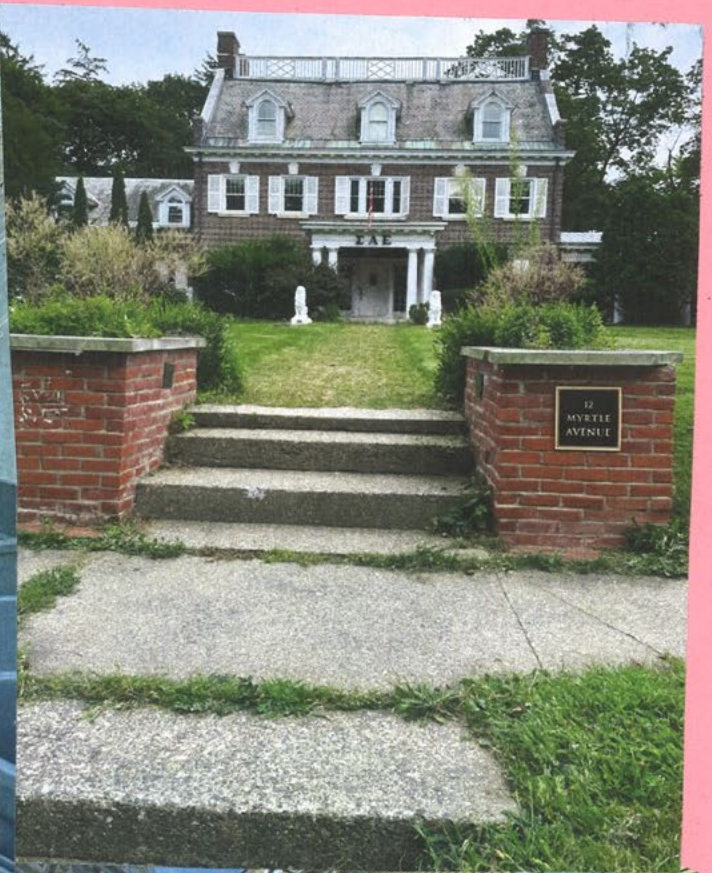
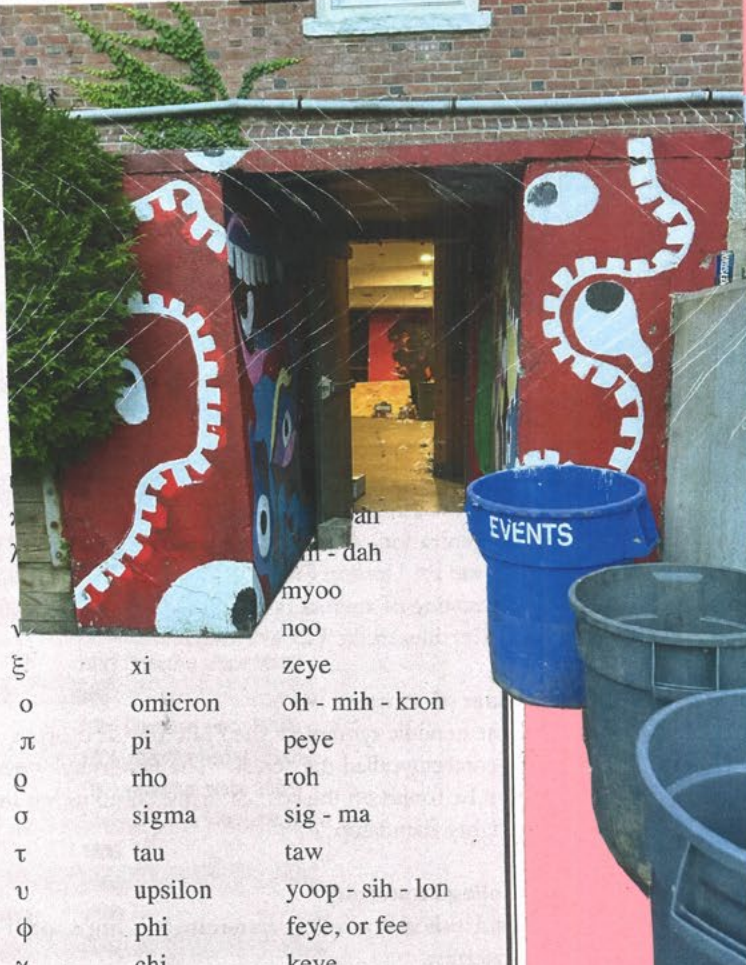

Greeting Alumni,

With the beginning of the fall semester comes many events, the most important of which is fall Rush. This is the most important rush in probably the last 10 years due to the fact that the present Brotherhood is shrinking at an alarming rate. By the time you receive this newsletter, Rush will be over and our house will be filled with happy little pledges. However, due to the fact that school has imparted a dry Rush on the fraternities, a little extra creativity which means more cash, was needed to have a successful Fall Rush. This, along with our small number of Brothers leaves the House with barely enough funds to make ends meet. In order to keep some of our regular fall events going like the Halloween party, Alumni Happy Hour, and Dinner Dance, the events in which you the alumni enjoy as well as the present Brothers, we need a little extra cash flow coming from somewhere else besides our regular dues and rent. This is why your donations are needed and very much appreciated. Thanx, see ya at Vision

Fraternally yours,

*C. CRIPPLE... I'M ON
a part of this group*

Robert [redacted]
Vice-President

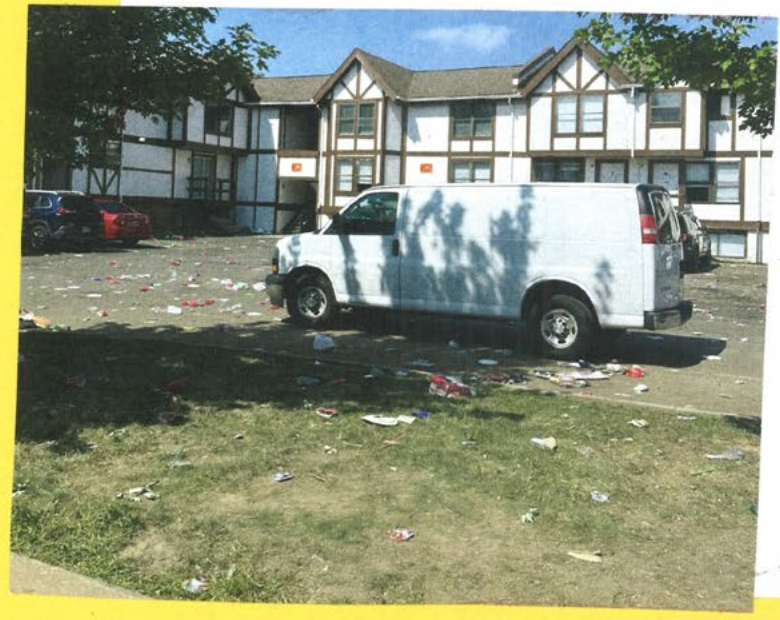

September 12, 2017

I just transferred to [redacted] this fall, and I can already say I love it so much better here than my previous school. A huge reason for this is how loving and welcoming the girls have been to me. As a [redacted] member at my previous school, it is the only sorority I can be in as an initiated member... but I wouldn't want it any other way. I am beyond lucky to have joined this chapter with such amazing, bright, and caring girls. Did I mention it is only the third week of school too? I can already say I love and care so much about each member of the sisterhood, and I think that says so much about this chapter. I've had SEVERAL girls reach out to be independent, wanting to get food or get to know me. As a transfer student, they don't know how much that means to me. In just a few months to a year, I can see myself creating friendships with these girls that will last a lifetime. I am beyond ~~see~~ excited to see what the future has in store for me within the chapter... I'm so beyond grateful to be a part of this group of women!!!!

♥Live by the sun, love by the moon♥

- Amanda [redacted]

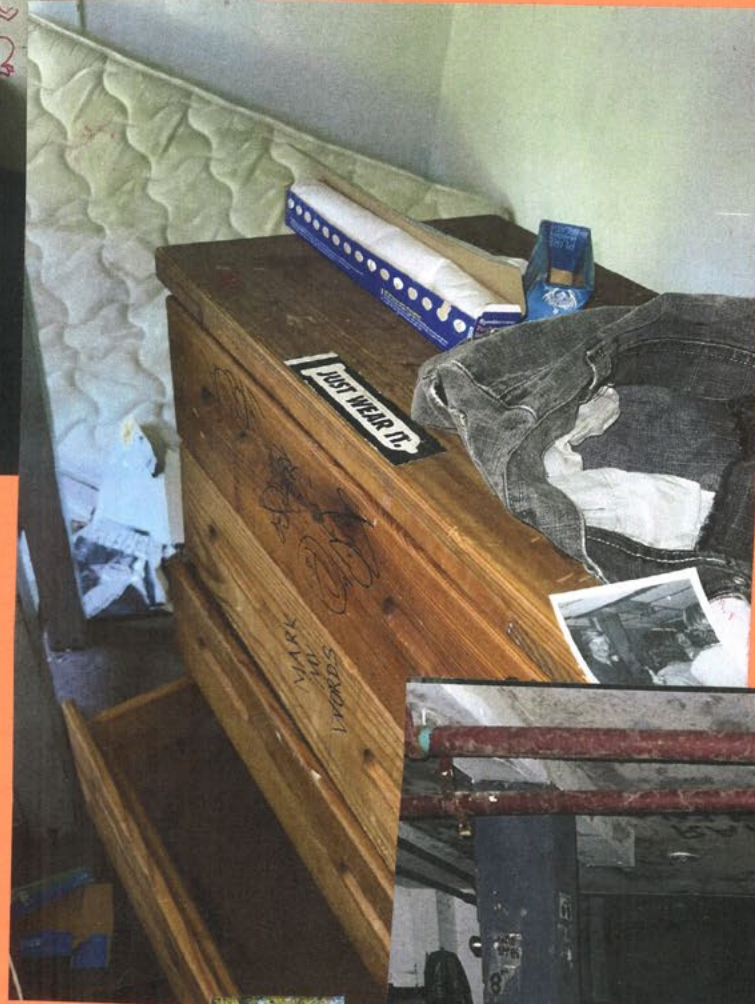

Share
and these the Homeless,
tempest-tost
to Me
My torch beside the
Golden door

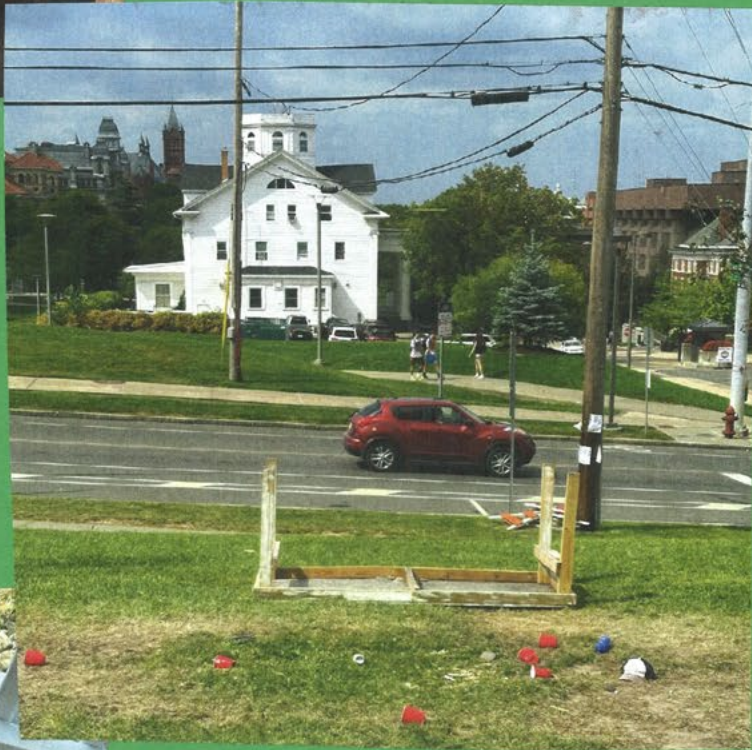
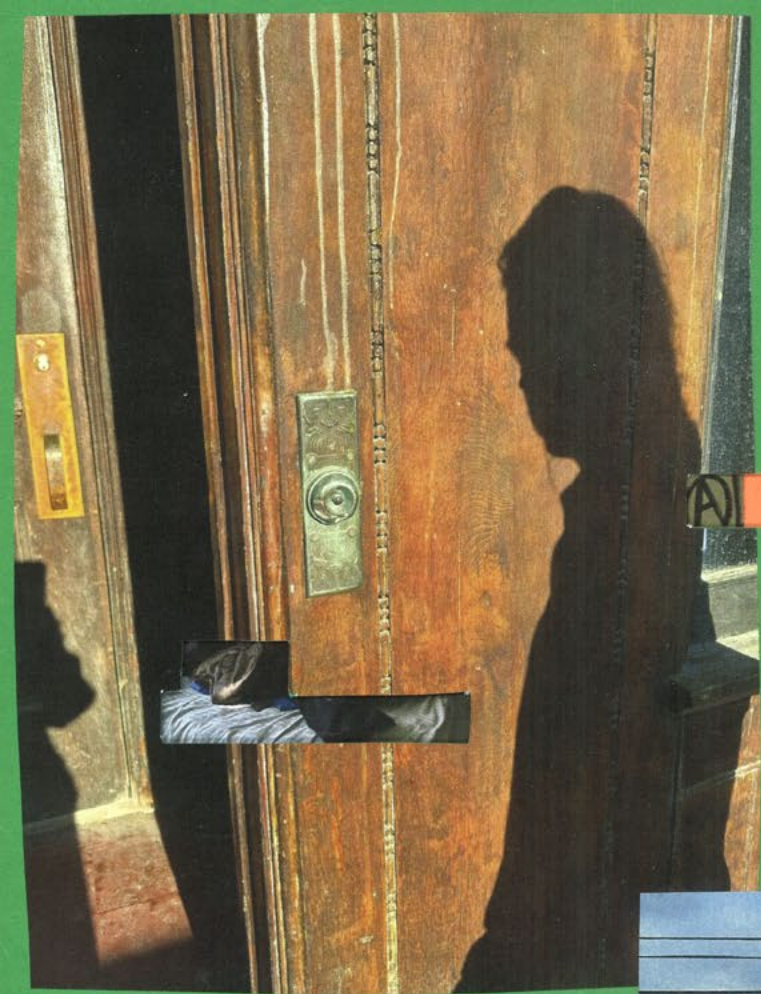

I HAVE NOT BEEN
NOR WILL I IN THE
FUTURE BE AN
EASY SOLUTION OR
A PLACE TO CAST
OFF YOUR FEARS
OF FALLING AND
BEING UNABLE TO
COME TO TERMS
WITH WHAT IN
REALITY IT IS
THAT YOU WERE
MISSING. THAT IS
SOMETHING THAT IS
HAVE LOST ALL

Twin,
Stay true
Stay blue
Stay you
Sleep tight
with all your might
because maryland is
closest to Flo Rida...
♡ Twinmm

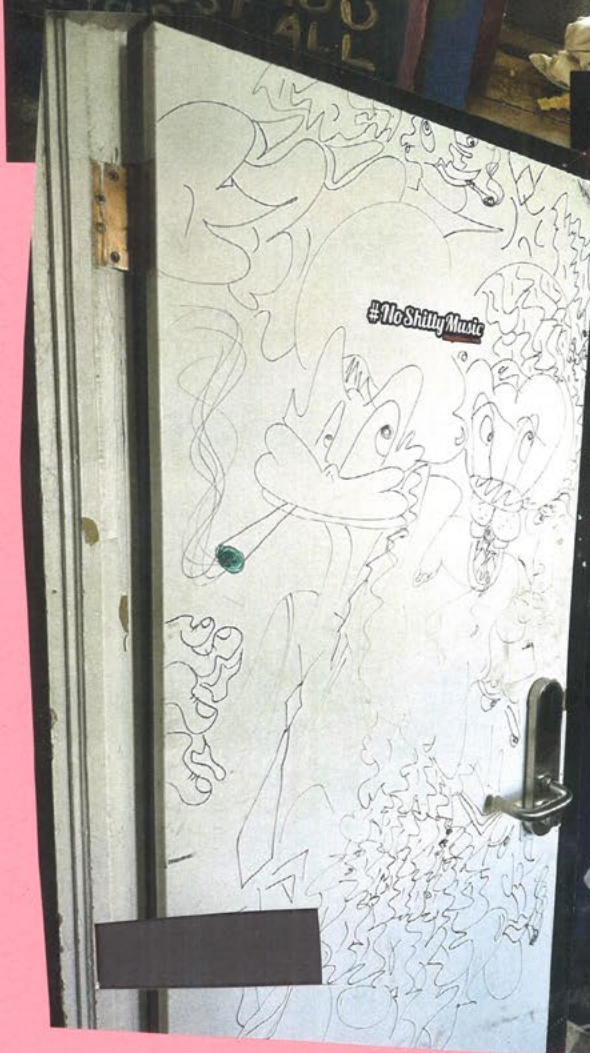

CANOE TRIP

IT'S THAT TIME AGAIN TO GET OUR ANNUAL CANOE TRIP TOGETHER. THIS YEAR WILL BE OUR 5TH CONSECUTIVE YEAR AND WE WILL ONCE AGAIN BE STAYING AT INDIAN HEAD CANOES IN BARRYVILLE, N.Y. WE ARE EXPECTING ANOTHER BIG TURNOUT OF APPROX. 90-100 PEOPLE. THIS YEAR'S TRIP WILL BE FROM FRIDAY MAY 11TH TO SUNDAY MAY 13TH. THE TOTAL COST OF THE TRIP WILL BE \$35.00, WHICH INCLUDES THE CAMPING FEE, CANOEING FEE AND 5 KEGS OF BEER. IF YOU ARE INTERESTED IN COMING I NEED A DEPOSIT OF \$20.00 BY MARCH 30TH NO LATER. THE BALANCE WILL BE PAID ON THE MORNING OF SATURDAY MAY 12TH UPON DEMAND!

FOR THE ALUMNI WHO HAVE NEVER EXPERIENCED A CANOE TRIP, THIS IS AN INFORMAL WAY OF GETTING IN TOUCH WITH OTHER ALUMNI AND THE BROTHERHOOD. WE HAVE HAD VERY GOOD ALUMNI PARTICIPATION IN THE PAST AND ARE EXPECTING AN EVEN LARGER TURNOUT THIS YEAR.

PLEASE SEND YOUR DEPOSIT TO THE HOUSE IN CARE OF ME. IF THERE ARE ANY QUESTIONS PLEASE CALL THE HOUSE AT [REDACTED] I'M LOOKING FORWARD TO SEEING YOU ON THE RIVER.

FRATERNALLY YOURS,

Juni [REDACTED]
VICE PRESIDENT



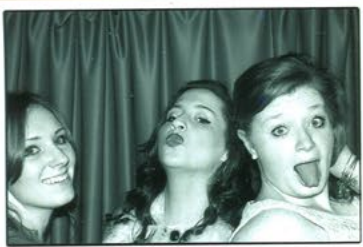

CHI OMEGA FALL FORMAL 2013

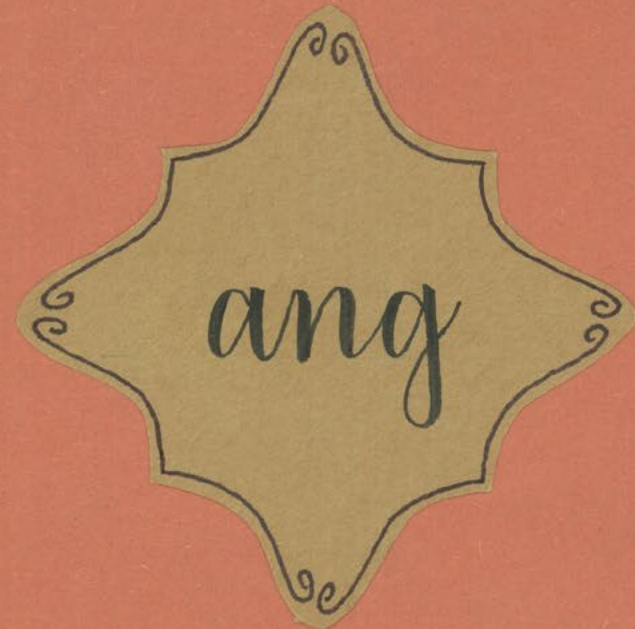

Brothers, Alumni, and most importantly, good friends... This is your resident deadhead Chris, formerly the most successful social director ever, now mutated into the MASTER of our pledges little worlds, bidding you good day. Now that the house is in pristine condition and a good deal of our bills paid off, we were able to set aside close to a thousand dollars for rush.



Casey's 22nd

BILL STRONG FUNDRAISER RAFFLE

5 TICKETS \$10

DONATE LIFE

NAME: _____

PHONE: _____

EMAIL: _____

THANK YOU FOR YOUR DONATION. ALL RAFFLE DRAWINGS WILL TAKE PLACE ON 2/21/214. IF YOU ARE NOT IN ATTENDANCE WE WILL CONTACT YOU BY PHONE OR EMAIL.

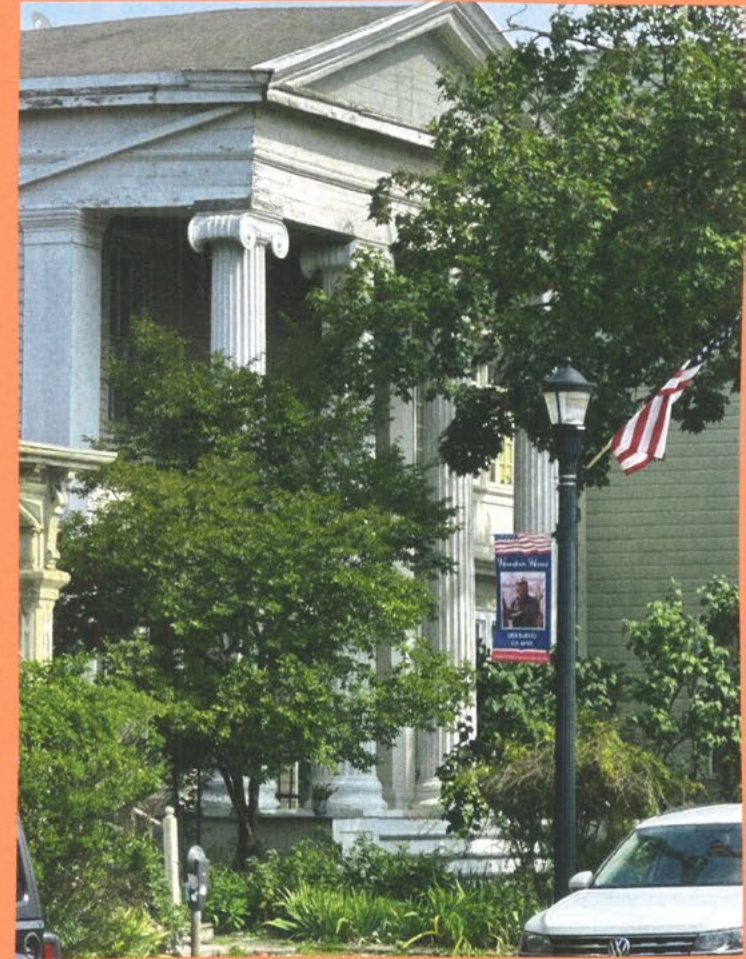

@PAGES 1:30 EVERYONE DOWNSTAIRS
2:00 MUSIC OFF.
CANCE TRIP: JUNE 6th, 7th, 8th
NO SEE DAZE \$ FOR 2 KEGS CUPS
✓ COZ
- CACENDER
- NOTCHEDS.
- 100 owed to house



As for the long term financial health of the frat it is imperative that all actives pay their bill on time or face eviction from the house. We see a recurring theme where certain actives accrue large debts then walk away from the bill just when the funds are most needed.

REVIEW



at America's Engagem
 n China Has Meant for

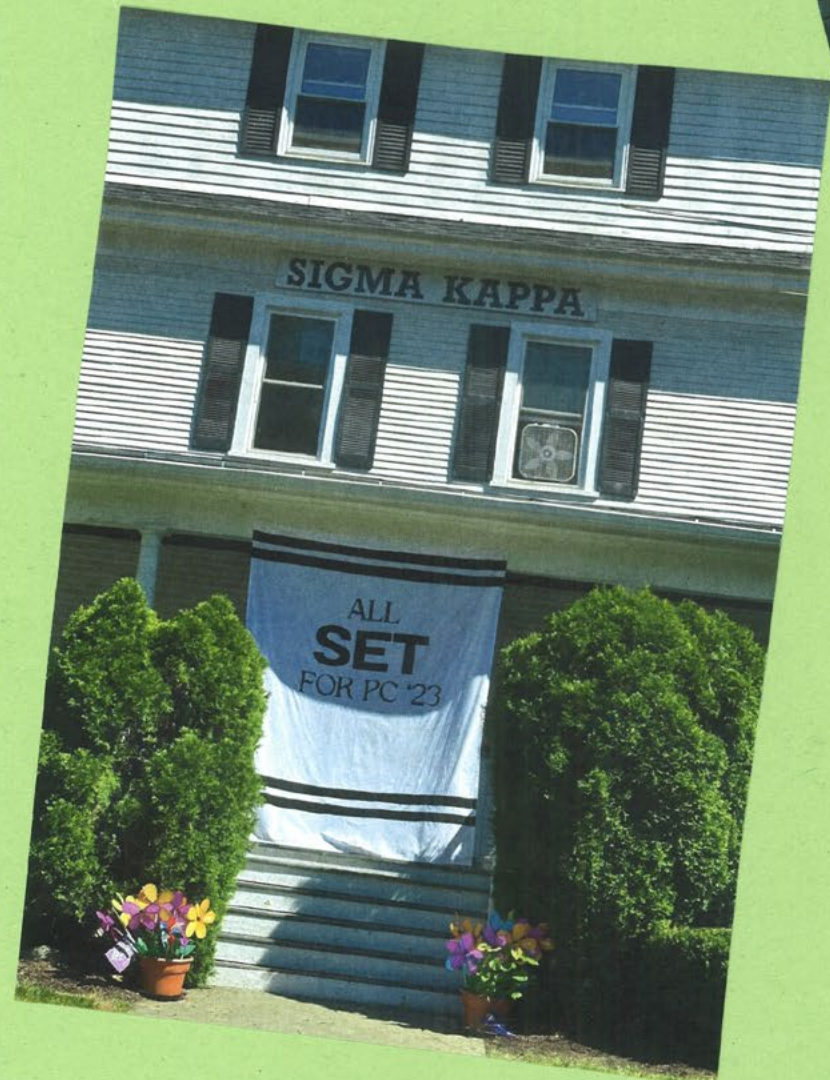



Riddle's presents ΠΥΣΗ, the first North American show of its kind. This scrapbook accompanies an exhibition survey of contemporary Greek Art in America, which opened on September 23, 2023 at Hudson House in Hudson, NY.

We want to clarify what we mean when we say contemporary Greek Art in America. With Hudson at the center of a 200 miles radius, we drove to over a dozen colleges, universities, and institutes who have established Greek Life organizations. We went door-to-door asking those living in sororities, fraternities, siblinghoods and any other organizations using Greek letters to submit works for this exhibition. We prefaced this ask by letting them know that what they gave us could be any sort of object from the house that they felt could be interesting in a gallery setting. Through an exchange and offering of trust, we are showing what we were given on these "studio visits."

Due to complications, our presently elected House Chairman, Bernard ██████, had to step down from office because he could not attend school this semester. He will be back in full force next semester. I, Mark ██████, have stepped up from assistant House Chairman to take over his position.

During the summer, the brotherhood held two productive work weekends. The total construction consisted of several projects. For one, a new roof was put onto the existing one. Also, the old backyard fence, on the right side lining the basketball court, was removed and a new one was put up. Furthermore, the television stand in the library was torn down, and a new one was built into the chimney behind it, thus making more space in the library. Finally, many other jobs pertaining to the general maintenance of the house were completed.

Up and coming construction includes fixing the leaking pipe in the basement. Although most brothers have no former experience in plumbing or construction, the advice that was received from alumni and friends was helpful. We are now able to proceed with the necessary construction.

With a small and somewhat inexperienced brotherhood, every task and chore seems like a hard one. The brotherhood appreciates any advice and help from alumni whether it be verbal, physical, or financial. Your opinions and advice are always welcomed.